

Grave Memorial Recording Form: St. John the Baptist, Westbourne, W. Sussex

1	National Grid Reference	755 073	Date	1	1	0	7	0	0
2	Name of recorder(s)	J. Storer							
3	Record No. of memorial (plus components i,ii,iii etc.)	N E B 2 0 0							
4	No. of components or inscribed faces (record on reverse if possible)	1							
5	Type of memorial: 1 = flat 2 = head 3 = tomb 4 = foot 5 = tablet 6 = other	3							
6	Material and geology	stone; limestone							
7	Stone mason or undertaker	none found							
8	Which surfaces inscribed (facing N, S, E or W)	S							
9	No. of people commemorated	1							
10	Condition of monument: 1=sound 2=displaced 3=leaning 4=collapsed 5=damaged	1							
11	Technique of inscription: 1 = incised 2 = carved in relief 3 = cast in relief 4 = lead letters 5 = painted	1							
12	Condition of inscription 1 = very good 2 = clear 3 = worn but decipherable 4 = partly legible 5 = illegible	3							
13	Dimensions (metric)	height	3	2	0	width	8	3	0
		Thickness (or length in case of tombs)	2	1	9	5			
14	Date of memorial	1843 +	Register	Frances Maria Smith, Racton, bu. 6 July 1843 aged 48					
Drawing or Photograph					Inscription				

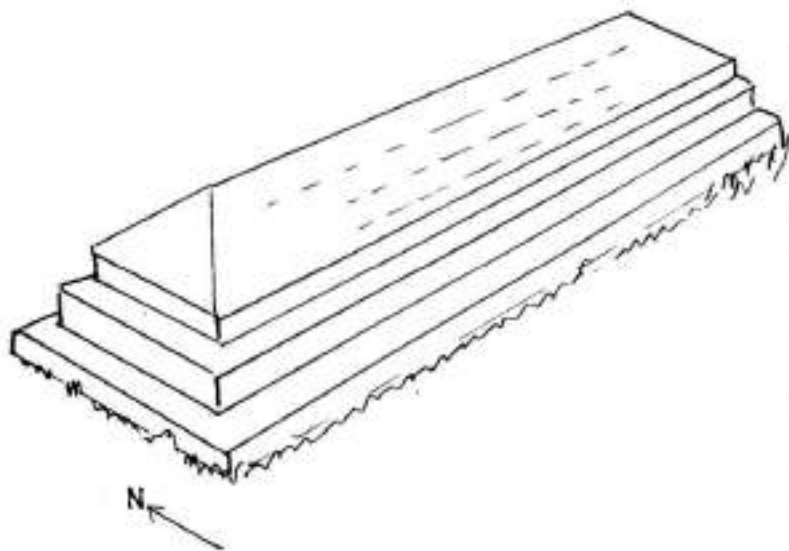

FRANCES MARIA SMITH
 STANSTED COTTAGE
 DIED 30 JUNE 1843

Grave Memorial Recording Form: St. John the Baptist, Westbourne, W. Sussex

1	National Grid Reference	755 073	Date	1	1	0	7	0	0
2	Name of recorder(s)	BERYL LINDER							
3	Record No. of memorial (plus components i,ii,iii etc.)	N	E	B	2	0	1		
4	No. of components or inscribed faces (record on reverse if possible)								1
5	Type of memorial: 1 = flat 2 = head 3 = tomb 4 = foot 5 = tablet 6 = other								2
6	Material and geology	LIMESTONE							
7	Stone mason or undertaker	NONE FOUND							
8	Which surfaces inscribed (facing N, S, E or W)								W
9	No. of people commemorated								2
10	Condition of monument: 1=sound 2=displaced 3=leaning 4=collapsed 5=damaged								1
11	Technique of inscription: 1 = incised 2 = carved in relief 3 = cast in relief 4 = lead letters 5 = painted								1
12	Condition of inscription 1 = very good 2 = clear 3 = worn but decipherable 4 = partly legible 5 = illegible								1
13	Dimensions (metric)	Plinth + height		1	3	1	0		
		width			6	8	0		
		Thickness (or length in case of tombs)				6	0		
14	Date of memorial	1846 +	Register Julia Shean (Polling)						
		Caroline Shean of Lunley a. 28 bu. 27 March 1846	bu. 13 June 1885						
Drawing or Photograph					Inscription				

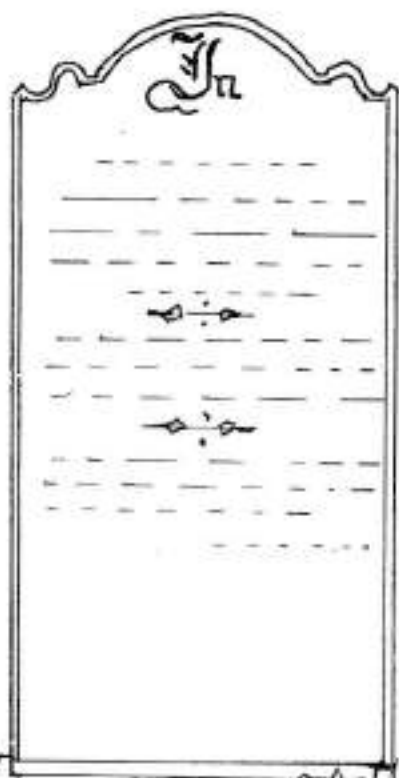

Jn

MEMORY OF

CAROLINE, DAUGHTER OF
WILLIAM & MARIA SHEAN
WHO DIED 22ND MARCH 1846
AGED 28 YEARS

ALSO OF JULIA, A SISTER AND
DAUGHTER OF THE ABOVE NAMED.
BORN 5TH FEB^R 1822. DIED 9TH JUNE 1885.

"IF WE BELIEVE THAT JESUS DIED AND ROSE
AGAIN, EVEN SO THEM ALSO WHICH SLEEP
JESUS WILL GOD BRING WITH HIM"

1. THESS. IV. 14

Grave Memorial Recording Form: St. John the Baptist, Westbourne, W. Sussex

1	National Grid Reference	755 023	Date	1	1	0	7	0	0
2	Name of recorder(s)	KEITH LINDER							
3	Record No. of memorial (plus components i,ii,iii etc.)	N E B			2	0	2		
4	No. of components or inscribed faces (record on reverse if possible)								
5	Type of memorial: 1 = flat 2 = head 3 = tomb 4 = foot 5 = tablet 6 = other	3							
6	Material and geology	STONE: LIMESTONE							
7	Stone mason or undertaker	NONE FOUND							
8	Which surfaces inscribed (facing N, S, E or W)				N	S			
9	No. of people commemorated	2							
10	Condition of monument: 1=sound 2=displaced 3=leaning 4=collapsed 5=damaged	5							
11	Technique of inscription: 1 = incised 2 = carved in relief 3 = cast in relief 4 = lead letters 5 = painted	1							
12	Condition of inscription 1 = very good 2 = clear 3 = worn but decipherable 4 = partly legible 5 = illegible	3							
13	Dimensions (metric)	height	3	3	0	width	7	1	5
		Thickness (or length in case of tombs)	1	9	5	5			
14	Date of memorial	1851 +	Register Maria bur. 22 May 1851 aged 70 William bur. 8 Jan. 1859 aged 71						
Drawing or Photograph					Inscription				

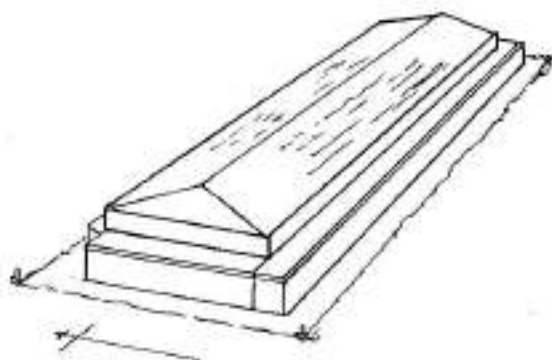

[NORTH FACE]

IN MEMORY OF
WILLIAM SHEAN,
WHO DIED ON THE 3RD JANUARY 1859
AGED 71 YEARS

[SOUTH FACE]

IN MEMORY OF
MARIA SHEAN,
WHO DIED ON THE 15TH MAY 1851
AGED 70 YEARS

Sp. William "Esq." of Lumley"

Grave Memorial Recording Form: St. John the Baptist, Westbourne, W. Sussex

1	National Grid Reference	755 073	Date	1	1	0	7	0	0
2	Name of recorder(s)	June Marshall							
3	Record No. of memorial (plus components i,ii,iii etc.)	N	E	B		2	0	3	
4	No. of components or inscribed faces (record on reverse if possible)								1
5	Type of memorial: 1 = flat 2 = head 3 = tomb 4 = foot 5 = tablet 6 = other								2
6	Material and geology	Limestone							
7	Stone mason or undertaker	NONE FOUND							
8	Which surfaces inscribed (facing N, S, E or W)								W
9	No. of people commemorated								1
10	Condition of monument: 1=sound 2=displaced 3=leaning 4=collapsed 5=damaged								1
11	Technique of inscription: 1 = incised 2 = carved in relief 3 = cast in relief 4 = lead letters 5 = painted								1.5
12	Condition of inscription 1 = very good 2 = clear 3 = worn but decipherable 4 = partly legible 5 = illegible								2
13	Dimensions (metric)	height	1	2	0	0			
		width		6	8	0			
		Thickness (or length in case of tombs)			6	0			
14	Date of memorial	1858+	Register George Shum Shean, Lumley, b.u. 26 Aug. 1858 aged 33						
Drawing or Photograph					Inscription				

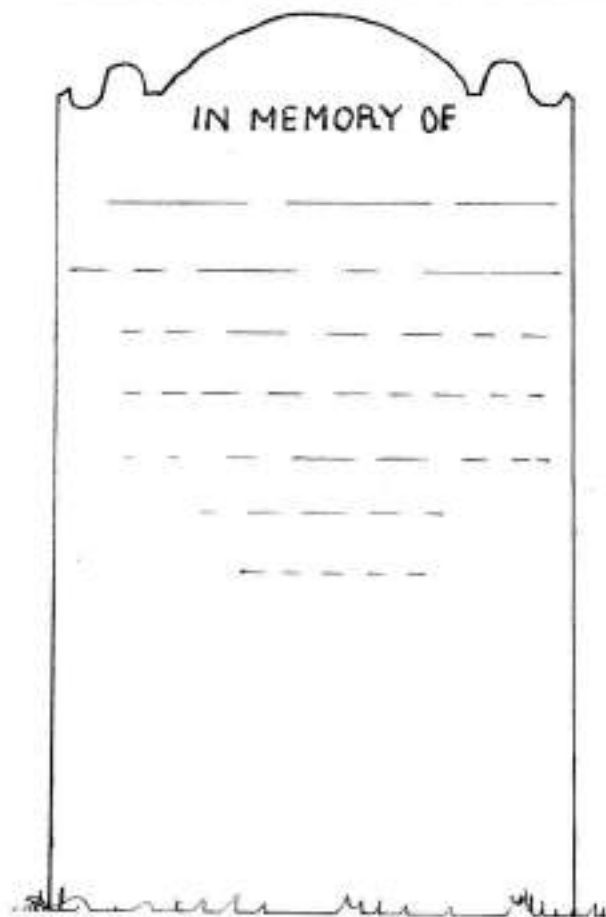

IN MEMORY OF
 GEORGE SHUM SHEAN
 Son of WILLIAM and MARIA SHEA
 who was drowned with three of
 his Friends in the upsetting
 of a boat in Emsworth Harbour
 August 21st 1858.
 Aged 33.

Two of the others who perished in this accident were Joseph Smith, also buried in Westbourne churchyard (no. NEB 138) and the Revd. Herbert Morse, curate of St. James's, Emsworth, who is buried in Warblington churchyard (no. SE 623 of the Warblington record). Morse was commemorated also by a tablet in St. James's Church, which gives a fuller account of the tragedy.

Grave Memorial Recording Form: St. John the Baptist, Westbourne, W. Sussex

1 National Grid Reference	755 073	Date	1	1	0	7	0	0
2 Name of recorder(s)	BERYL LINDER							
3 Record No. of memorial (plus components i,ii,iii etc.)	N	E	B		2	0	4	
4 No. of components or inscribed faces (record on reverse if possible)								
5 Type of memorial: 1 = flat 2 = head 3 = tomb 4 = foot 5 = tablet 6 = other	2							
6 Material and geology	LIMESTONE							
7 Stone mason or undertaker	NONE FOUND							
8 Which surfaces inscribed (facing N, S, E or W)								
9 No. of people commemorated	2							
10 Condition of monument: 1=sound 2=displaced 3=leaning 4=collapsed 5=damaged	1							
11 Technique of inscription: 1 = incised 2 = carved in relief 3 = cast in relief 4 = lead letters 5 = painted	1 5							
12 Condition of inscription 1 = very good 2 = clear 3 = worn but decipherable 4 = partly legible 5 = illegible	2							
13 Dimensions (metric)	height	1	1	9	0			
	width		9	2	0			
	Thickness (or length in case of tombs)			6	0			
14 Date of memorial 1801 or 1804+ Register Rebecca, w. of John Brown bu. 12 Jan. 1801 John Brown bu. 14 Jan. 1804								
Drawing or Photograph	Inscription							

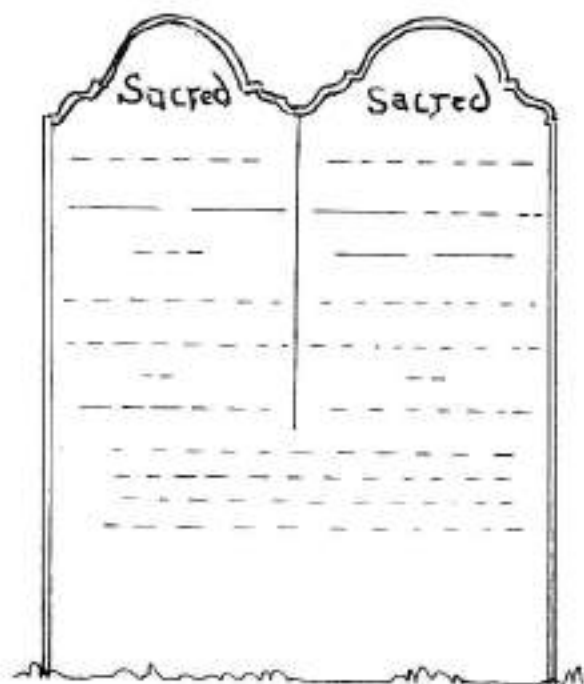

Sacred	Sacred
to the Memory of JOHN BROWN Who departed this life the 11 th of January 1804 in the 63 rd Year of his Age	to the Memory of REBECCA Wife of JOHN BROWN who departed this life the 7 th of January 1801 in the 64 th Year of her Age

*Remember Death's the surest lot
To all that in this World remain
Altho' our bones consume and rot
We trust in Christ to live again.*

remains of black in line around edge.
long 9 short s are thus.

Grave Memorial Recording Form: St. John the Baptist, Westbourne, W. Sussex

1	National Grid Reference	755 073	Date	1	1	0	7	0	0	
2	Name of recorder(s)	KEITH LINDER								
3	Record No. of memorial (plus components i,ii,iii etc.)	N		E		B		2	0	5
4	No. of components or inscribed faces (record on reverse if possible)	1								
5	Type of memorial: 1 = flat 2 = head 3 = tomb 4 = foot 5 = tablet 6 = other	3								
6	Material and geology	STONE: LIMESTONE								
7	Stone mason or undertaker	NONE FOUND								
8	Which surfaces inscribed (facing N, S, E or W)	5								
9	No. of people commemorated	1								
10	Condition of monument: 1=sound 2=displaced 3=leaning 4=collapsed 5=damaged	1								
11	Technique of inscription: 1 = Incised 2 = carved in relief 3 = cast in relief 4 = lead letters 5 = painted	1								
12	Condition of inscription 1 = very good 2 = clear 3 = worn but decipherable 4 = partly legible 5 = illegible	2								
13	Dimensions (metric)	height	3	3	0	width	7	1	5	
		Thickness (or length in case of tombs)	2	0	0	0				
14	Date of memorial	1849+	Register James Brown bu. Nov. 3 rd 1849 aged 73							
Drawing or Photograph					Inscription					

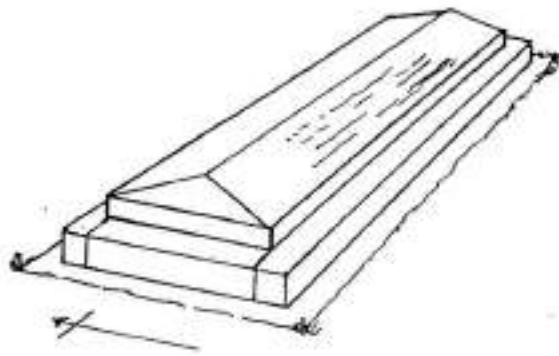

[SOUTH SLOPE:]

SACRED to the Memory of
JAMES BROWN
 who died the 27th of October 1849
 Aged 73 Years

Grave Memorial Recording Form: St. John the Baptist, Westbourne, W. Sussex

1	National Grid Reference	755 073	Date	11	1	0	7	0	0					
2	Name of recorder(s)	KEITH LINDER												
3	Record No. of memorial (plus components i,ii,iii etc.)	N E B			2			0 6						
4	No. of components or inscribed faces (record on reverse if possible)													
5	Type of memorial: 1 = flat 2 = head 3 = tomb 4 = foot 5 = tablet 6 = other	3												
6	Material and geology	STONE: LIMESTONE												
7	Stone mason or undertaker	NONE FOUND												
8	Which surfaces inscribed (facing N, S, E or W)				N		E		S					
9	No. of people commemorated	2												
10	Condition of monument: 1=sound 2=displaced 3=leaning 4=collapsed 5=damaged	5												
11	Technique of inscription: 1 = incised 2 = carved in relief 3 = cast in relief 4 = lead letters 5 = painted	1												
12	Condition of inscription 1 = very good 2 = clear 3 = worn but decipherable 4 = partly legible 5 = illegible	3												
13	Dimensions (metric)	height	3	7	0	width	7	5	0	Thickness (or length in case of tombs)	1	9	7	0
14	Date of memorial	1857 +	Register Mary d. of John & Rebecca Brown bu. 15 Dec. 1786 Phyllis Brown, Westbourne, bu. 13 June 1857, a. 74											
Drawing or Photograph						Inscription								

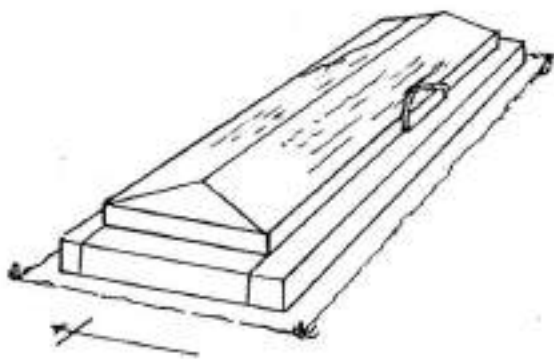

NORTH FACE:

SACRED TO THE MEMORY OF

PHILLISS BROWN

WHO DIED THE 8TH OF JUNE 1857

AGED 74 YEARS

SOUTH FACE:

SACRED TO THE MEMORY OF

MARY BROWN,

WHO DIED THE 13TH OF DECEMBER 1786

AGED 6 YEARS

Grave Memorial Recording Form: St. John the Baptist, Westbourne, W. Sussex

1	National Grid Reference	755 073	Date	1	8	0	7	0	0
2	Name of recorder(s)	KEITH LINDER							
3	Record No. of memorial (plus components i,ii,iii etc.)	N E B		2		0		7	
4	No. of components or inscribed faces (record on reverse if possible)	1							
5	Type of memorial: 1 = flat 2 = head 3 = tomb 4 = foot 5 = tablet 6 = other	2							
6	Material and geology	STONE: LIMESTONE							
7	Stone mason or undertaker	NONE FOUND							
8	Which surfaces inscribed (facing N, S, E or W)								W
9	No. of people commemorated	1							
10	Condition of monument: 1=sound 2=displaced 3=leaning 4=collapsed 5=damaged								3
11	Technique of inscription: 1 = incised 2 = carved in relief 3 = cast in relief 4 = lead letters 5 = painted								1
12	Condition of inscription 1 = very good 2 = clear 3 = worn but decipherable 4 = partly legible 5 = illegible								1
13	Dimensions (metric)	height	5	6	0	width	6	4	0
		Thickness (or length in case of tombs)	8		5				
14	Date of memorial	1727 +	Register Henry Oliver bu. 23 Dec 1727						
Drawing or Photograph					Inscription				

IN MEMORY
 of HENRY OLLIVER Who
 Died December 21st
 1727 Aged 52 Years
 Man is y seed God is y sowe
 Man is y grass death is y mowe
 My time my life My days are
 past to My long home

IN MEMORY
 of HENRY OLLIVER Who
 Died December 21st
 1727 Aged 52 Years
 Man is y seed God is y sowe
 Man is y grass death is y mowe
 My time my life My days are
 past to My long home I am got
 at last

Grave Memorial Recording Form: St. John the Baptist, Westbourne, W. Sussex

1	National Grid Reference	755 073	Date	1	2	0	9	0	0
2	Name of recorder(s)	DAPHNE COOPER							
3	Record No. of memorial (plus components i,ii,iii etc.)	N E B		2		0		8	
4	No. of components or inscribed faces (record on reverse if possible)	1							
5	Type of memorial: 1 = flat 2 = head 3 = tomb 4 = foot 5 = tablet 6 = other	2							
6	Material and geology	LIMESTONE							
7	Stone mason or undertaker	NONE FOUND							
8	Which surfaces inscribed (facing N, S, E or W)								W
9	No. of people commemorated								3
10	Condition of monument: 1=sound 2=displaced 3=leaning 4=collapsed 5=damaged								1
11	Technique of inscription: 1 = incised 2 = carved in relief 3 = cast in relief 4 = lead letters 5 = painted								1
12	Condition of inscription 1 = very good 2 = clear 3 = worn but decipherable 4 = partly legible 5 = illegible								2
13	Dimensions (metric)	height	1	3	4	0			
		width	6		3	0			
		Thickness (or length in case of tombs)	7		0				
14	Date of memorial	1842+ (or 1839+) Register Anne White, Woodmancote, bu. 22 Sept. Elizabeth Esther White, Woodmancote, bu. 21 Nov. 1839 a. 10 // 1842, a. 24							
Drawing or Photograph					Inscription				

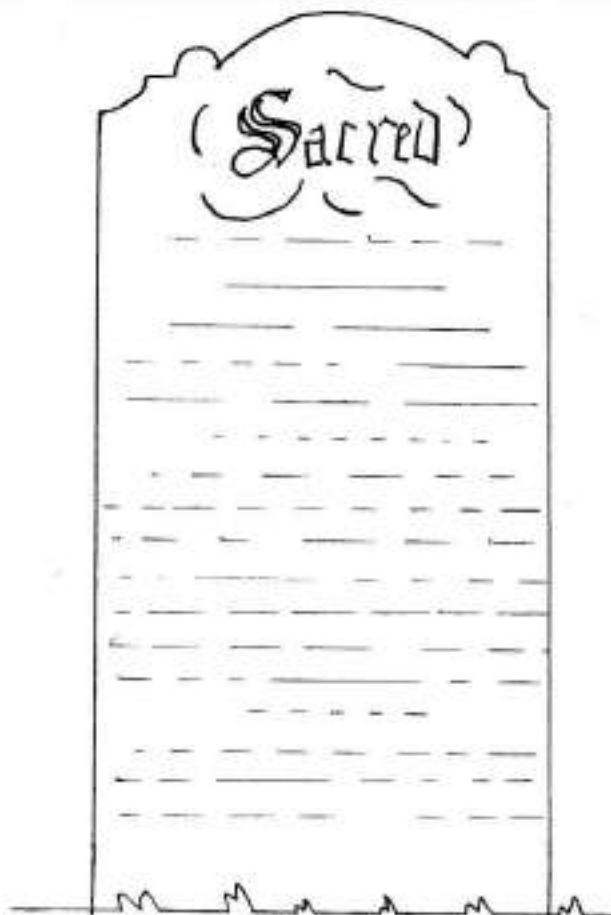

(Sacred)

to the Memory of
**ELIZABETH
 ESTHER WHITE**
 Daughter of THOMAS and
 ANN CLARK WHITE
 Of WOODMANCOTE
 who departed this Life
 the 16th of November 1839
 Aged 10 Years and 5 Months
 Also of ANN eldest Daughter of
 the above named THOMAS and
 ANN CLARK WHITE
 who Died the 18th of September 1842
 Aged 24 Years
 The Lord gave and the Lord hath
 Taken away Blessed be the name
 of the Lord. Job 1st Chap 21st v

Footstone is no. NW 92

Grave Memorial Recording Form: St. John the Baptist, Westbourne, W. Sussex

1 National Grid Reference	755 073	Date	1	1	0	7	0	0
2 Name of recorder(s)	Veronica Jay							
3 Record No. of memorial (plus components i,ii,iii etc.)	N	E	B		2	0	9	
4 No. of components or inscribed faces (record on reverse if possible)								
5 Type of memorial: 1 = flat 2 = head 3 = tomb 4 = foot 5 = tablet 6 = other	2							
6 Material and geology	LIMESTONE							
7 Stone mason or undertaker	NONE FOUND							
8 Which surfaces inscribed (facing N, S, E or W)	W							
9 No. of people commemorated	2							
10 Condition of monument: 1=sound 2=displaced 3=leaning 4=collapsed 5=damaged	3							
11 Technique of inscription: 1 = incised 2 = carved in relief 3 = cast in relief 4 = lead letters 5 = painted	5 1							
12 Condition of inscription 1 = very good 2 = clear 3 = worn but decipherable 4 = partly legible 5 = illegible	2							
13 Dimensions (metric)	height	1	3	1	0			
	width		5	9	0			
	Thickness (or length in case of tombs)			6	5			
14 Date of memorial 1828+	Register John Rogers, Westbourne, bu. 4 Sept.							
	Sarah Rogers, Westbourne, bu. 12 November, 1845 a. 86 // 1828. a. 72							
Drawing or Photograph					Inscription			

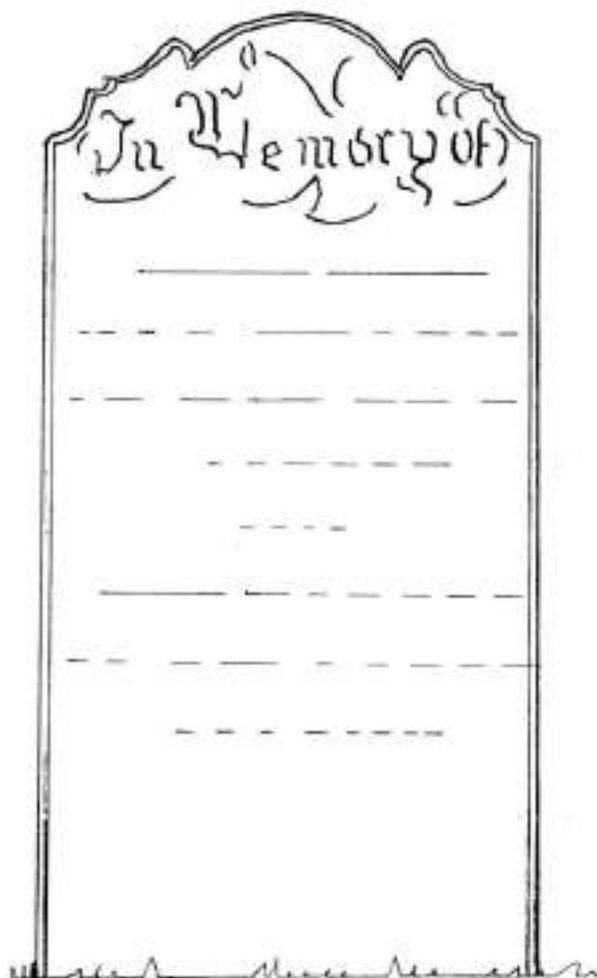

In Memory of

JOHN ROGERS
Late of Atherfield, Isle of Wight
who died August the 31 1828
Aged 72 Years
Also
SARAH Wife of the above
who died November the 8th 1845
Aged 86 Years

Grave Memorial Recording Form: St. John the Baptist, Westbourne, W. Sussex

1	National Grid Reference	755 073	Date	1	8	0	7	0	0
2	Name of recorder(s)	DAPHNE COOPER							
3	Record No. of memorial (plus components i,ii,iii etc.)	N E B		2		1		0	
4	No. of components or inscribed faces (record on reverse if possible)	1							
5	Type of memorial: 1 = flat 2 = head 3 = tomb 4 = foot 5 = tablet 6 = other	2							
6	Material and geology	LIMESTONE							
7	Stone mason or undertaker	NONE FOUND							
8	Which surfaces inscribed (facing N, S, E or W)								W
9	No. of people commemorated	2							
10	Condition of monument: 1=sound 2=displaced 3=leaning 4=collapsed 5=damaged								1
11	Technique of inscription: 1 = incised 2 = carved in relief 3 = cast in relief 4 = lead letters 5 = painted								1
12	Condition of inscription 1 = very good 2 = clear 3 = worn but decipherable 4 = partly legible 5 = illegible								4
13	Dimensions (metric)	height	1	1	5	5			
		width		6	4	0			
		Thickness (or length in case of tombs)			6	0			
14	Date of memorial	1813+	Register	James s. of William & Ann Barnes bu. 25 Nov. 1793 // Henrys. of William & Ann Barnes bu. 10 Aug. 1813 a. 24					
Drawing or Photograph					Inscription				

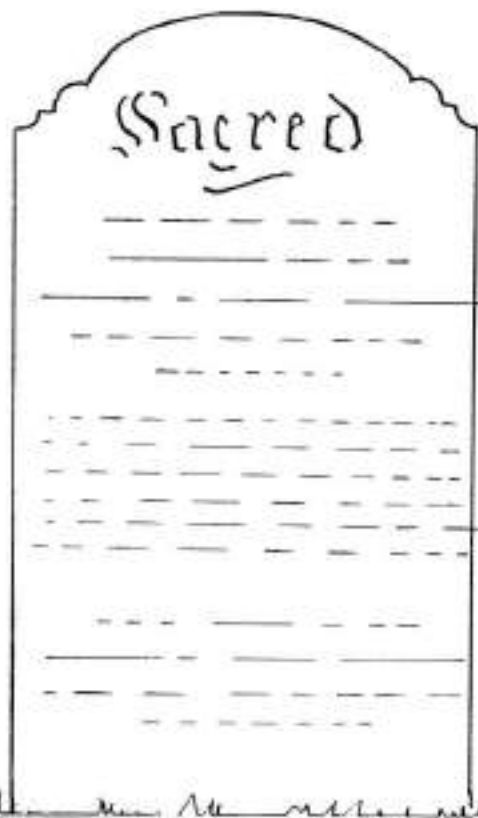

Sacred
to the Memory of
HARRY Son of
WILLIAM and ANN BARNES
who died August 15th 1813
Aged 24 Years

D. --- Friend of. [?lay]
D. --- [away]
After a long decay of Life
It pleased GOD to end the strife
As this my fate so yours may be
Therefore prepare to follow me

Also JAMES Son of
WILLIAM and ANN BARNES
who died Nov^r 12th 1793
Aged 15 Months

Confusion between Barnes, Barnes & Barnes
in register & inscription.

(Sperling's record no. 4.....)

Grave Memorial Recording Form: St. John the Baptist, Westbourne, W. Sussex

1	National Grid Reference	755 073	Date	3	0	1	0	0	1
2	Name of recorder(s)	BERYL LINDER							
3	Record No. of memorial (plus components I, II, III etc.)	N E B			2			1 1	
4	No. of components or inscribed faces (record on reverse if possible)								
5	Type of memorial: 1 = flat 2 = head 3 = tomb 4 = foot 5 = tablet 6 = other	2							
6	Material and geology	LIMESTONE							
7	Stone mason or undertaker	NONE FOUND							
8	Which surfaces inscribed (facing N, S, E or W)								W
9	No. of people commemorated	1							
10	Condition of monument: 1=sound 2=displaced 3=leaning 4=collapsed 5=damaged								3
11	Technique of inscription: 1 = incised 2 = carved in relief 3 = cast in relief 4 = lead letters 5 = painted								1
12	Condition of inscription 1 = very good 2 = clear 3 = worn but decipherable 4 = partly legible 5 = illegible								1
13	Dimensions (metric)	height	1	2	7	0			
		width		7	4	0			
		Thickness (or length in case of tombs)			7	5			
14	Date of memorial	1834 +	Register John Ayling bu. 4 Apr. 1834, a. 32						

Drawing or Photograph

Inscription



Sacred

*to the Memory of
JOHN AYLING
who departed this Life
the 26th of March 1834
Aged 32 Years*

Grave Memorial Recording Form: St. John the Baptist, Westbourne, W. Sussex

1	National Grid Reference	755 073	Date	2	5	0	7	0	0
2	Name of recorder(s)	JOHN LAMPLUGH							
3	Record No. of memorial (plus components i,ii,iii etc.)	N	E	B		2	1	2	
4	No. of components or inscribed faces (record on reverse if possible)								1
5	Type of memorial: 1 = flat 2 = head 3 = tomb 4 = foot 5 = tablet 6 = other								2
6	Material and geology	limestone							
7	Stone mason or undertaker	none found							
8	Which surfaces inscribed (facing N, S, E or W)								W
9	No. of people commemorated								2
10	Condition of monument: 1=sound 2=displaced 3=leaning 4=collapsed 5=damaged								3
11	Technique of inscription: 1 = incised 2 = carved in relief 3 = cast in relief 4 = lead letters 5 = painted								1
12	Condition of inscription 1 = very good 2 = clear 3 = worn but decipherable 4 = partly legible 5 = illegible								3
13	Dimensions (metric)	height	1	6	0	0			
		width		7	5	5			
		Thickness (or length in case of tombs)			7	0			
14	Date of memorial	1844+	Register	Charles Louch, Portsmouth bu. 5 Nov. 1844, aged 64					
	Sarah Louch, Clifton, Bristol, bur. 5 Jan. 1858 aged 78								
	Drawing or Photograph				Inscription				



THE MEMORY OF
MR CHARLES LOUCH
 for many years Deputy Storekeeper
 at Gravesend
 who departed this life Nov^r 1844
 Aged 64 Years
 ———
 Also
SARAH LOUCH
 wife of the above
 who died December 31st 1857.
 Aged 79 Years
 ———

traces of paint in border line

Grave Memorial Recording Form: St. John the Baptist, Westbourne, W. Sussex

1	National Grid Reference	755 073	Date	2	5	0	7	0	0
2	Name of recorder(s)	BERYL LINDER							
3	Record No. of memorial (plus components i,ii,iii etc.)	N E B 2 1 3							
4	No. of components or inscribed faces (record on reverse if possible)	1							
5	Type of memorial: 1 = flat 2 = head 3 = tomb 4 = foot 5 = tablet 6 = other	2							
6	Material and geology	LIMESTONE : PORTLAND TYPE							
7	Stone mason or undertaker	NONE FOUND							
8	Which surfaces inscribed (facing N, S, E or W)	W							
9	No. of people commemorated	Originally two 2							
10	Condition of monument: 1=sound 2=displaced 3=leaning broken; top half 4=collapsed 5=damaged	missing 3 5							
11	Technique of inscription: 1 = incised 2 = carved in relief 3 = cast in relief 4 = lead letters 5 = painted	1 5							
12	Condition of inscription 1 = very good 2 = clear 3 = worn but decipherable 4 = partly legible 5 = illegible	4							
13	Dimensions (metric)	height	7	5	0	width	7	6	0
		Thickness (or length in case of tombs)		7	0				
14	Date of memorial	Probably 1826 Register Mary Louch, Hermitage, bu. 31 Jan. 1832 aged 80							
		Richard Louch bu. 30 Oct. 1826 aged 72							
	Drawing or Photograph	Inscription							

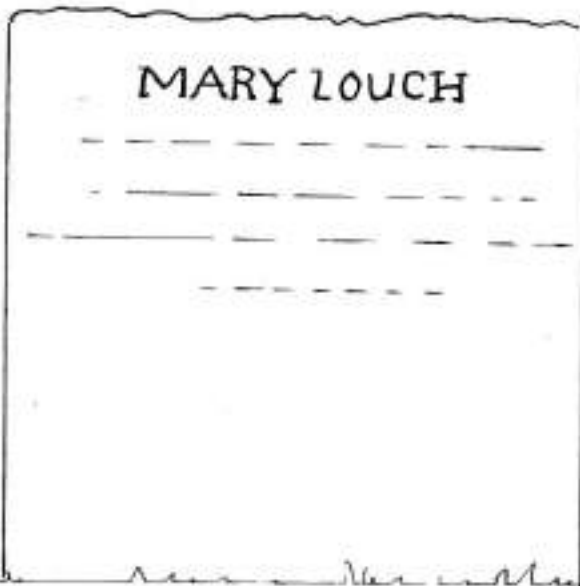

MARY LOUCH
 the Wife of the above
 who departed this Life
 the 26th day of January 1832
 Aged 80 Years

missing section apparently commemorated Richard Louch (according to Spurling) d. Oct. 24, 1826, a. 75.

Footstone OV 654

Grave Memorial Recording Form: St. John the Baptist, Westbourne, W. Sussex

1	National Grid Reference	755 073	Date	3	0	0	5	0	0	
2	Name of recorder(s)	KEITH LINDER								
3	Record No. of memorial (plus components i,ii,iii etc.)	N		E		B		2	1	4
4	No. of components or inscribed faces (record on reverse if possible)									1
5	Type of memorial: 1 = flat 2 = head 3 = tomb 4 = foot 5 = tablet 6 = other									2
6	Material and geology	STONE : LIMESTONE								
7	Stone mason or undertaker	NONE FOUND								
8	Which surfaces inscribed (facing N, S, E or W)									W
9	No. of people commemorated									1
10	Condition of monument: 1=sound 2=displaced 3=leaning 4=collapsed 5=damaged									1
11	Technique of inscription: 1 = incised 2 = carved in relief 3 = cast in relief 4 = lead letters 5 = painted									1
12	Condition of inscription 1 = very good 2 = clear 3 = worn but decipherable 4 = partly legible 5 = illegible									1
13	Dimensions (metric)	height		1	1	6	0			
		width			6	3	0			
		Thickness (or length in case of tombs)				7	0			
14	Date of memorial	1786+	Register Elizabeth w. of Thomas Clear Sen ^r by 11 Feb. 1786							
Drawing or Photograph					Inscription					



the Memory of
ELIZABETH CLEAR
 wife of **THOMAS CLEAR**
 who departed this life
 February the 11th 1786
 Aged 19 Years

*From Cares remov'd sleeps peaceful here
 A loving Wife a Mother dear
 Though parting wraps our Souls in Grief
 From Heaven flows this kind Relief
 That we shall meet on that blest Shore
 Where Tears and Sorrows are no more*

To
 the Memory of
ELIZABETH CLEAR
 wife of **THOMAS CLEAR**
 who departed this life
 February the 11th 1786
 Aged 49 Years

*From Cares remov'd sleeps peaceful here
 A loving Wife a Mother dear
 Though parting wraps our Souls in Grief
 From Heaven flows this kind Relief:
 That we shall meet on that blest Shore
 Where Tears and Sorrows are no more.*

Grave Memorial Recording Form: St. John the Baptist, Westbourne, W. Sussex

1	National Grid Reference	755 073	Date	2	8	7	0	0
2	Name of recorder(s)	SHIRLEY HARVEY-WHITING.						
3	Record No. of memorial (plus components i,ii,iii etc.)	N E B		2	1	5		
4	No. of components or inscribed faces (record on reverse if possible)							
5	Type of memorial: 1 = flat 2 = head 3 = tomb 4 = foot 5 = tablet 6 = other							2
6	Material and geology	STONE : LIMESTONE						
7	Stone mason or undertaker	NONE FOUND						
8	Which surfaces inscribed (facing N, S, E or W)							W
9	No. of people commemorated							1
10	Condition of monument: 1=sound 2=displaced 3=leaning 4=collapsed 5=damaged							3
11	Technique of inscription: 1 = incised 2 = carved in relief 3 = cast in relief 4 = lead letters 5 = painted							1
12	Condition of inscription 1 = very good 2 = clear 3 = worn but decipherable 4 = partly legible 5 = illegible							2
13	Dimensions (metric)	height	1	4	3	0		
		width		8	7	0		
		Thickness (or length in case of tombs)			7	0		
14	Date of memorial	1808 +	Register not found; April 1808 - April 1809 missing					
Drawing or Photograph				Inscription				



Happy the Man whose tender care
Relieves the poor distressed:
When he's by trouble compass'd round,
The Lord shall give him rest.

To the memory of
THOMAS CLEAR
who departed this life
the 14th of April 1808
Aged 72 years

Happy the Man whose tender care
Relieves the poor distressed:
When he's by trouble compass'd round,
The Lord shall give him rest.

design whiting 1808

Grave Memorial Recording Form: St. John the Baptist, Westbourne, W. Sussex

1	National Grid Reference	755 073	Date	27	6	0	0
2	Name of recorder(s)	SHIRLEY HARVEY-WHITING.					
3	Record No. of memorial (plus components i,ii,iii etc.)	N	E	B	2	1	6
4	No. of components or inscribed faces (record on reverse if possible)						
5	Type of memorial: 1 = flat 2 = head 3 = tomb 4 = foot 5 = tablet 6 = other	2					
6	Material and geology	LIMESTONE					
7	Stone mason or undertaker	NONE FOUND					
8	Which surfaces inscribed (facing N, S, E or W)	W					
9	No. of people commemorated	2					
10	Condition of monument: 1=sound 2=displaced 3=leaning 4=collapsed 5=damaged	3					
11	Technique of inscription: 1 = incised 2 = carved in relief 3 = cast in relief 4 = lead letters 5 = painted	1					
12	Condition of inscription 1 = very good 2 = clear 3 = worn but decipherable 4 = partly legible 5 = illegible	1					
13	Dimensions (metric)	height	1	1	2	0	
		width		6	8	0	
		Thickness (or length in case of tombs)			7	2	
14	Date of memorial	28.10.1781 / 17.4.1802	Register	Stephen Palmer bu 23 Oct. 1781 Ann Palmer, widow, bu 21 April 1802			
Drawing or Photograph				Inscription			



The Memory of
STEPHEN PALMER
who departed this Life
the 28th of October 1781
Aged 38 Years
Also
ANN Wife of
STEPHEN PALMER
who departed this life
the 17th of April 1802
Aged 84 Years

the Memory of
STEPHEN PALMER
who departed this Life
the 28th of October 1781
Aged 38 Years
Also
ANN Wife of
STEPHEN PALMER
who departed this life
the 17th of April 1802
Aged 84 Years

There is a discrepancy between dates
of Stephen's death & burial

Grave Memorial Recording Form: St. John the Baptist, Westbourne, W. Sussex

1 National Grid Reference	155 073	Date	2	0	0	6	0	0	
2 Name of recorder(s)	John Lamplugh								
3 Record No. of memorial (plus components i,ii,iii etc.)	N	E	B		2	1	7		
4 No. of components or inscribed faces (record on reverse if possible)									
5 Type of memorial: 1 = flat 2 = head 3 = tomb 4 = foot 5 = tablet 6 = other	2								
6 Material and geology	LIMESTONE								
7 Stone mason or undertaker	NONE FOUND								
8 Which surfaces inscribed (facing N, S, E or W)	W								
9 No. of people commemorated	1								
10 Condition of monument: 1=sound 2=displaced 3=leaning 4=collapsed 5=damaged	(5) below ground 5 3								
11 Technique of inscription: 1 = incised 2 = carved in relief 3 = cast in relief 4 = lead letters 5 = painted	1								
12 Condition of inscription 1 = very good 2 = clear 3 = worn but decipherable 4 = partly legible 5 = illegible	3								
13 Dimensions (metric)	height	1	0	4	0	width	6	1	0
	Thickness (or length in case of tombs)			7	0				
14 Date of memorial 1759 +	Register Ann w. of Henry Housom bu. 2 Jun 1759								
	Catherine D. of Henry Housom bu. 30 Jun. 1760								
Drawing or Photograph					Inscription				

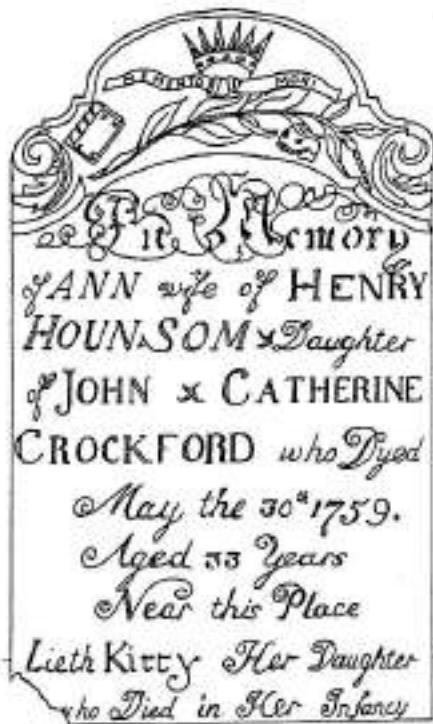

In Memory
of ANN wife of HENRY
HOUNSOM & Daughter
of JOHN & CATHERINE
CROCKFORD who Dyed
May the 30th 1759.
Aged 33 Years
Near this Place
Lieth Kitty Her Daughter
who Died in Her Infancy



In Memory

of ANN wife of HENRY
HOUNSOM & Daughter
of JOHN & CATHERINE
CROCKFORD who Dyed

May the 30th 1759.

Aged 33 Years

Near this Place

*Lieth Kitty Her Daughter
who Died in Her Infancy*

Ground level

Grave Memorial Recording Form: St. John the Baptist, Westbourne, W. Sussex

1	National Grid Reference	755 073	Date	1	1	7	0	0
2	Name of recorder(s)	SHIRLEY HARVEY-WHITING.						
3	Record No. of memorial (plus components i,ii,iii etc.)	N	E	B	2	1	8	
4	No. of components or inscribed faces (record on reverse if possible)							
5	Type of memorial: 1 = flat 2 = head 3 = tomb 4 = foot 5 = tablet 6 = other							2
6	Material and geology	STONE - LIMESTONE						
7	Stone mason or undertaker	NONE FOUND						
8	Which surfaces inscribed (facing N, S, E or W)							W
9	No. of people commemorated							1
10	Condition of monument: 1=sound 2=displaced 3=leaning 4=collapsed 5=damaged							3
11	Technique of inscription: 1 = incised 2 = carved in relief 3 = cast in relief 4 = lead letters 5 = painted							2
12	Condition of inscription 1 = very good 2 = clear 3 = worn but decipherable 4 = partly legible 5 = illegible							1
13	Dimensions (metric)	height	8	9	0			
		width	5	4	5			
		Thickness (or length in case of tombs)	7	0				
14	Date of memorial	1763 +	Register Catherine Crockford widow no. 9 Dec. 1763					
Drawing or Photograph					Inscription			

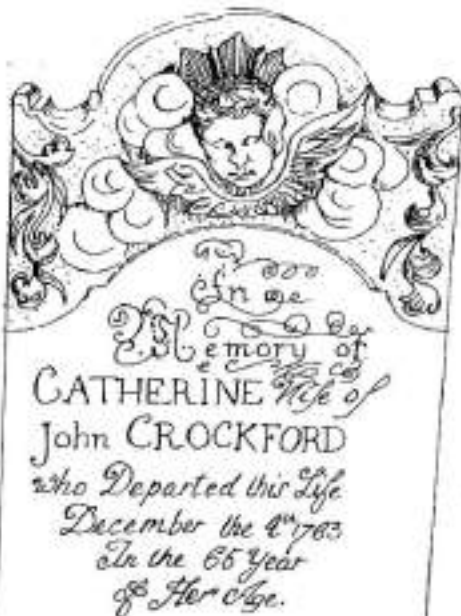

In memory of
 CATHERINE Wife of
 John CROCKFORD
 who Departed this Life
 December the 4th 1763
 In the 65 year
 of Her Age.

Grave Memorial Recording Form: St. John the Baptist, Westbourne, W. Sussex

1	National Grid Reference	155 013	Date	0	4	0	7	0	0
2	Name of recorder(s)	KEITH LINDER							
3	Record No. of memorial (plus components i,ii,iii etc.)	N E B 2 1 9							
4	No. of components or inscribed faces (record on reverse if possible)	1							
5	Type of memorial: 1 = flat 2 = head 3 = tomb 4 = foot 5 = tablet 6 = other	2							
6	Material and geology	STONE: LIMESTONE							
7	Stone mason or undertaker	NONE FOUND							
8	Which surfaces inscribed (facing N, S, E or W)	W							
9	No. of people commemorated	1							
10	Condition of monument: 1=sound 2=displaced 3=leaning 4=collapsed 5=damaged	1							
11	Technique of inscription: 1 = incised 2 = carved in relief 3 = cast in relief 4 = lead letters 5 = painted	1							
12	Condition of inscription 1 = very good 2 = clear 3 = worn but decipherable 4 = partly legible 5 = illegible	3							
13	Dimensions (metric)	height	1	2	4	5			
		width		7	5	0			
		Thickness (or length in case of tombs)			7	5			
14	Date of memorial 1813 +	Register Sarah Diggins (widow) of Emsworth, bu. 9 July 1813 aged 62.							
Drawing or Photograph					Inscription				

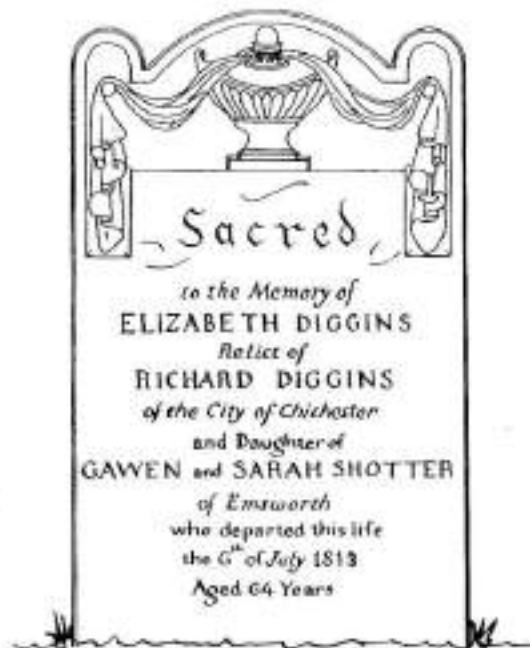

Sacred

to the Memory of
ELIZABETH DIGGINS
Relict of
RICHARD DIGGINS
of the City of Chichester
and Daughter of
GAWEN and SARAH SHOTTER
of Emsworth
who departed this life
the 6th of July 1813
Aged 64 Years

Grave Memorial Recording Form: St. John the Baptist, Westbourne, W. Sussex

1	National Grid Reference	755 073	Date	1	8	0	7	0	0
2	Name of recorder(s)	KEITH LINDER							
3	Record No. of memorial (plus components i,ii,iii etc.)	N E B 2 2 0							
4	No. of components or inscribed faces (record on reverse if possible)	1							
5	Type of memorial: 1 = flat 2 = head 3 = tomb 4 = foot 5 = tablet 6 = other	2							
6	Material and geology	STONE: LIMESTONE							
7	Stone mason or undertaker	NONE FOUND							
8	Which surfaces inscribed (facing N, S, E or W)								W
9	No. of people commemorated	2							
10	Condition of monument: 1=sound 2=displaced 3=leaning 4=collapsed 5=damaged	FALLEN FACE DOWN 5 4							
11	Technique of inscription: 1 = incised 2 = carved in relief 3 = cast in relief 4 = lead letters 5 = painted	1							
12	Condition of inscription 1 = very good 2 = clear 3 = worn but decipherable 4 = partly legible 5 = illegible	1							
13	Dimensions (metric)	height	1	5	7	0			
		width		7	1	5			
		Thickness (or length in case of tombs)			7	0			
14	Date of memorial	1796 +	Register Sarah Shotter bu. 9 Jan 1796 Elizabeth not found						
Drawing or Photograph					Inscription				

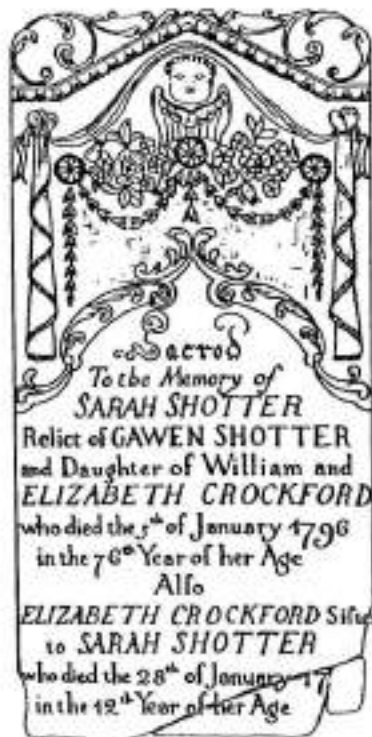

Sacred
 To the Memory of
SARAH SHOTTER
 Relict of GAWEN SHOTTER
 and Daughter of William and
ELIZABETH CROCKFORD
 who died the 5th of January 1796
 in the 76th Year of her Age
 Also
ELIZABETH CROCKFORD Sister
 to **SARAH SHOTTER**
 who died the 28th of January 1771
 in the 12th Year of her Age *

THE STONE SNAPPED AT THE BASE AND WAS REPAIRED WITH IRON STRAPS. IT BROKE AGAIN AND FELL WITH THE INSCRIPTION DOWNWARDS. THE FACE OF THE STONE HAS NOT WEATHERED AND HAS RETAINED ITS ORIGINAL WHITE COLOUR.

* 1733 or 1753; Sperling gives 1733 and age 42. 1733 and age 12 seem most likely.

Grave Memorial Recording Form: St. John the Baptist, Westbourne, W. Sussex

1 National Grid Reference	755 073	Date	0	1	0	8	0	0
2 Name of recorder(s)	KEITH LINDER							
3 Record No. of memorial (plus components i,ii,iii etc.)	N E S		2		2		1	
4 No. of components or inscribed faces (record on reverse if possible)	1							
5 Type of memorial: 1 = flat 2 = head 3 = tomb 4 = foot 5 = tablet 6 = other	2							
6 Material and geology	STONE: LIMESTONE							
7 Stone mason or undertaker	NONE FOUND							
8 Which surfaces inscribed (facing N, S, E or W)								W
9 No. of people commemorated	2							
10 Condition of monument: 1=sound 2=displaced 3=leaning forward slightly 4=collapsed 5=damaged								3
11 Technique of inscription: 1 = incised 2 = carved in relief 3 = cast in relief 4 = lead letters 5 = painted								1
12 Condition of inscription 1 = very good 2 = clear 3 = worn but decipherable 4 = partly legible 5 = illegible								3
13 Dimensions (metric)	height	1	3	4	0			
	width		7	0	0			
	Thickness (or length in case of tombs)			8	5			
14 Date of memorial	1769 +	Register GAWEN (sic) SHOTTER bu. 9 "June" 1769						
<i>(NB Surrounding entries in register indicate that the month should be "July"; baptism not Sarah d. of GAWEN SHOTTER bu. 8 July 1740 // found 1702 - 1706 - parts difficult to read)</i>								
Drawing or Photograph					Inscription			

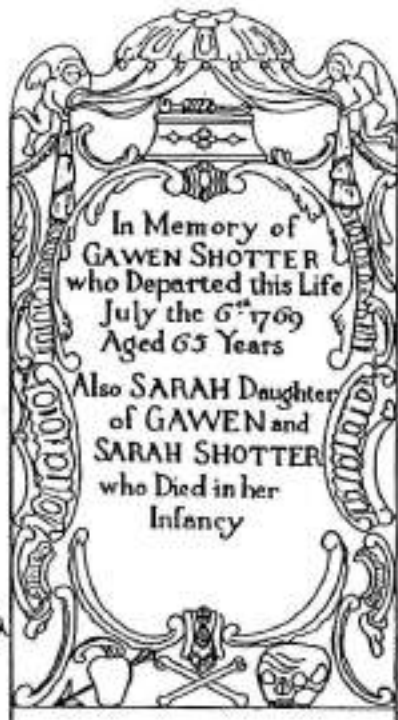

In Memory of
GAWEN SHOTTER
 who Departed this Life
 July the 6th 1769
 Aged 65 Years

[?6:]

Also SARAH Daughter
 of GAWEN and
SARAH SHOTTER
 who Died in her
 Infancy

Grave Memorial Recording Form: St. John the Baptist, Westbourne, W. Sussex

1	National Grid Reference	755 073	Date	2	9	0	7	0	0
2	Name of recorder(s)	Benjamin Alive-Jones							
3	Record No. of memorial (plus components I,II,III etc.)	N	E	B	2	2	2		
4	No. of components or inscribed faces (record on reverse if possible)								1
5	Type of memorial: 1 = flat 2 = head 3 = tomb 4 = foot 5 = tablet 6 = other								2
6	Material and geology	Limestone			Sperling's record no. 37				
7	Stone mason or undertaker	not found							
8	Which surfaces inscribed (facing N, S, E or W)								W
9	No. of people commemorated								1
10	Condition of monument: 1=sound 2=displaced 3=leaning 4=collapsed 5=damaged								1
11	Technique of inscription: 1 = incised 2 = carved in relief 3 = cast in relief 4 = lead letters 5 = painted								1
12	Condition of inscription 1 = very good 2 = clear 3 = worn but decipherable 4 = partly legible 5 = illegible								2
13	Dimensions (metric)	height	6	7	5				
		width	5	8	5				
		Thickness (or length in case of tombs)		9	0				
14	Date of memorial	1732+	Register	Mary da ^r of Will ^m & Elizabeth Crockford bu 8 March 1733					
	Drawing or Photograph	Inscription							



This Stone
is in MEMORY of ~
Mary Daughter of W^m
& Elizabeth CROCKFORD
Who died March the 6th
1733 in ^e 10th Year of
her AGE

DEAR parents do not grieu for^{US}
for we are happy with the Just

Upper and lower case letters
are thus.

Grave Memorial Recording Form: St. John the Baptist, Westbourne, W. Sussex

1	National Grid Reference	755 073	Date	2	4	0	7	0	0
2	Name of recorder(s)	June Marshall							
3	Record No. of memorial (plus components i,ii,iii etc.)	N	E	B		2	2	3	
4	No. of components or inscribed faces (record on reverse if possible)								
5	Type of memorial: 1 = flat 2 = head 3 = tomb 4 = foot 5 = tablet 6 = other	2							
6	Material and geology	Limestone							
7	Stone mason or undertaker	none found							
8	Which surfaces inscribed (facing N, S, E or W)								W
9	No. of people commemorated	1							
10	Condition of monument: 1=sound 2=displaced 3=leaning 4=collapsed 5=damaged	1							
11	Technique of inscription: 1 = incised 2 = carved in relief 3 = cast in relief 4 = lead letters 5 = painted	1							
12	Condition of inscription 1 = very good 2 = clear 3 = worn but decipherable 4 = partly legible 5 = illegible	2							
13	Dimensions (metric)	height	6	8	5	width	6	3	5
		Thickness (or length in case of tombs)		9	0				
14	Date of memorial	1754 +	Register Will ^m Crockford bu. 3 Mar. 1754						
Drawing or Photograph					Inscription				

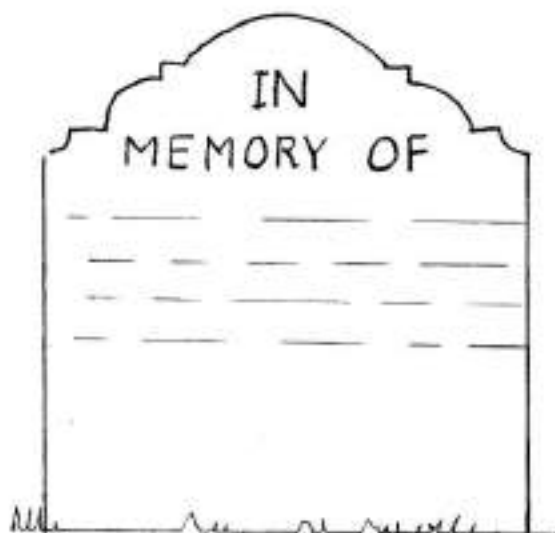

IN
MEMORY OF
WILLIAM CROCKFORD
Senor Who Departed
this Life February 28th
1754 Aged 68 Years

Senor sic

Grave Memorial Recording Form: St. John the Baptist, Westbourne, W. Sussex

1 National Grid Reference	755 073	Date	0	1	0	8	0	0
2 Name of recorder(s)	June Marshall							
3 Record No. of memorial (plus components I, II, III etc.)	N	E	B		2	2	4	
4 No. of components or inscribed faces (record on reverse if possible)								
5 Type of memorial: 1 = flat 2 = head 3 = tomb 4 = foot 5 = tablet 6 = other	2							
6 Material and geology	Limestone							
7 Stone mason or undertaker	Not known							
8 Which surfaces inscribed (facing N, S, E or W)	W							
9 No. of people commemorated	3							
10 Condition of monument: 1=sound 2=displaced 3=leaning (some pitting on surface) 4=collapsed 5=damaged	1							
11 Technique of inscription: 1 = incised 2 = carved in relief 3 = cast in relief 4 = lead letters 5 = painted	1							
12 Condition of inscription 1 = very good 2 = clear 3 = worn but decipherable 4 = partly legible 5 = illegible	3							
13 Dimensions (metric)	height	1	3	0	0			
	width		7	2	5			
	Thickness (or length in case of tombs)			7	0			
14 Date of memorial	1825	Register Rebecca Ayling, Leigh, bu. 28 Oct. 1825						
	Robert Ayling, Printhead, bu. 21 Apr. 1827 a. 16 //	a. 66						
	William Ayling, East Leigh, Havant, bu. 15 Dec. 1828 a. 19							
	Drawing or Photograph	Inscription						

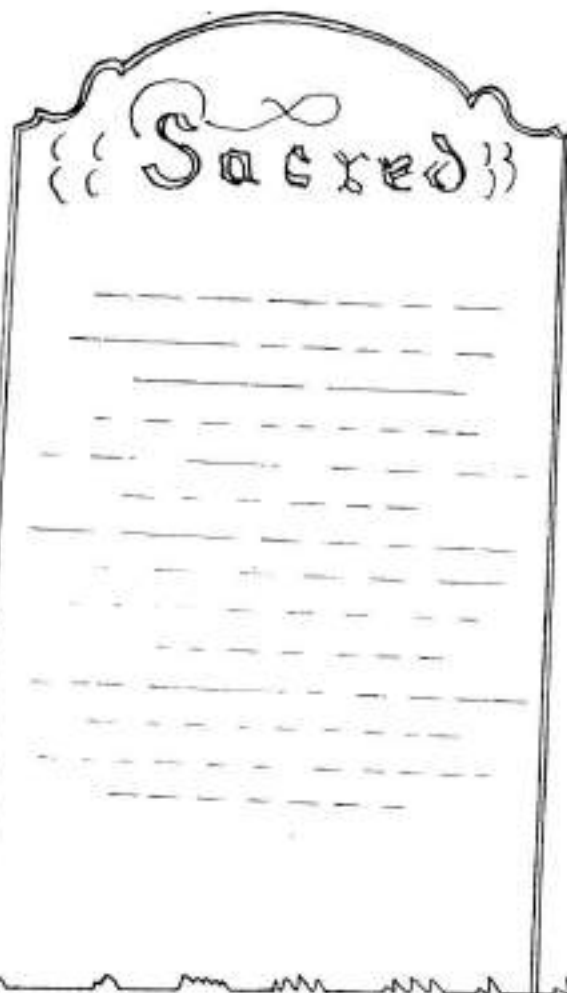

{{ Sacred. }}

to the Memory of
REBECCA, Wife of
JOHN AYLING
who departed this Life
the 26th of October 1825

** Aged [?] Years
Also ROBERT, Son of the above
who departed this Life
the 18th of April 1827
Aged 17. Years
Also WILLIAM, Son of the above
who departed this Life
* the 1[?]th of December 1828
Aged 19 Years

* apparently 18, could be 13 or 15.

** discrepancy with register in Rebecca's age

Grave Memorial Recording Form: St. John the Baptist, Westbourne, W. Sussex

1 National Grid Reference	155 073	Date	2	5	0	7	0	0
2 Name of recorder(s)	JOSEPHINE HALLETT							
3 Record No. of memorial (plus components I,ii,iii etc.)	N	E	B		2	2	5	
4 No. of components or inscribed faces (record on reverse if possible)								
5 Type of memorial: 1 = flat 2 = head 3 = tomb 4 = foot 5 = tablet 6 = other	2							
6 Material and geology	LIMESTONE							
7 Stone mason or undertaker	NONE FOUND							
8 Which surfaces inscribed (facing N, S, E or W)	W							
9 No. of people commemorated	1							
10 Condition of monument: 1=sound 2=displaced 3=leaning 4=collapsed 5=damaged	1							
11 Technique of inscription: 1 = incised 2 = carved in relief 3 = cast in relief 4 = lead letters 5 = painted	1							
12 Condition of inscription 1 = very good 2 = clear 3 = worn but decipherable 4 = partly legible 5 = illegible	2							
13 Dimensions (metric)	height	1	2	9	5			
	width		7	0	5			
	Thickness (or length in case of tombs)			6	5			
14 Date of memorial	1856 +	Register	James Elsegood Griffin, Enswarth bu. 26 Sept 1856 age 17					
Drawing or Photograph				Inscription				

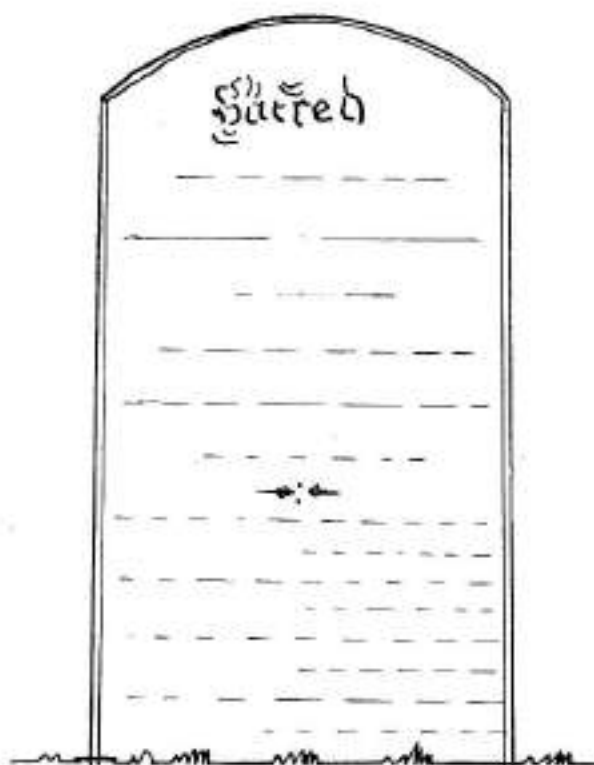

Dacted

TO THE MEMORY OF
JAMES ELSEGOOD
GRIFFIN.

who departed this life .
the 22nd of September 1856 .
Aged 17 Years

◆:◆

Dearly lov'd ones, I must leave you,
Mourn not for me .
Let not my departure grieve you,
Mourn not for me .
On redeeming grace relying, Satan
Death and doubt defying,
Looking unto Christ, I'm dying,
Mourn not for me.

Grave Memorial Recording Form: St. John the Baptist, Westbourne, W. Sussex

1	National Grid Reference	755 073	Date	2	5	0	7	0	0
2	Name of recorder(s)	DAPHNE COOPER							
3	Record No. of memorial (plus components i,ii,iii etc.)	N E S			2			2 6	
4	No. of components or inscribed faces (record on reverse if possible)	1							
5	Type of memorial: 1 = flat 2 = head 3 = tomb 4 = foot 5 = tablet 6 = other	2							
6	Material and geology	LIMESTONE							
7	Stone mason or undertaker	NONE FOUND							
8	Which surfaces inscribed (facing N, S, E or W)								W
9	No. of people commemorated	2							
10	Condition of monument: 1=sound 2=displaced 3=leaning 4=collapsed 5=damaged								1
11	Technique of inscription: 1 = incised 2 = carved in relief 3 = cast in relief 4 = lead letters 5 = painted								1
12	Condition of inscription 1 = very good 2 = clear 3 = worn but decipherable 4 = partly legible 5 = illegible								2
13	Dimensions (metric)	height	1	2	7	0			
		width					6	7	0
		Thickness (or length in case of tombs)					6	0	
14	Date of memorial	1856+	Register George Griffin, Portsea, bu. 27 Jan.						
		John Griffin, Emsworthy	bu. 10 Mar. 1856, a. 95//				// 1823, a. 22		
		formerly of this parish.							
Drawing or Photograph					Inscription				



See: All the stones

Sacred
 TO THE MEMORY OF
 JOHN GRIFFIN.
 who departed this life,
 the 4th of March 1856.
 Aged 95 Years.
 —:—
 Also of
 GEORGE GRIFFIN
 SON OF THE ABOVE:
 who departed this life
 the 22nd of January 1823
 Aged 22 Years
 —:—

Grave Memorial Recording Form: St. John the Baptist, Westbourne, W. Sussex

1 National Grid Reference	755 073	Date	1	6	0	5	0	1
2 Name of recorder(s)	DAPHNE COOPER							
3 Record No. of memorial (plus components i,ii,iii etc.)	N E B			2		2		7
4 No. of components or inscribed faces (record on reverse if possible)	1							
5 Type of memorial: 1 = flat 2 = head 3 = tomb 4 = foot 5 = tablet 6 = other	2							
6 Material and geology	LIMESTONE							
7 Stone mason or undertaker	NONE FOUND							
8 Which surfaces inscribed (facing N, S, E or W)								W
9 No. of people commemorated								2
10 Condition of monument: 1=sound 2=displaced 3=leaning 4=collapsed 5=damaged								3
11 Technique of inscription: 1 = incised 2 = carved in relief 3 = cast in relief 4 = lead letters 5 = painted								1
12 Condition of inscription 1 = very good 2 = clear 3 = worn but decipherable 4 = partly legible 5 = illegible								2
13 Dimensions (metric)	height	1	2	0	0			
	width	6		4	0			
	Thickness (or length in case of tombs)			6	5			
14 Date of memorial	1856+	Register Sophia Knight, Ellbridge,						
	Emily Knights, Ellbridge, bu. 3 Nov, 1856, a-13 //	bu. 11 July 1856 a. 42						
Drawing or Photograph					Inscription			



Sacred

TO THE MEMORY OF
SOPHIA, wife of
JOSEPH KNIGHT
who died July the 6th 1856.
Aged 23 Years

Also of EMILY.
daughter of the above
who died Nov^r the 21st 1856
Aged 13 Years.

Grave Memorial Recording Form: St. John the Baptist, Westbourne, W. Sussex

1	National Grid Reference	755 073	Date	0	8	0	8	0	0
2	Name of recorder(s)	JOSEPHINE HALLETT							
3	Record No. of memorial (plus components I,II,III etc.)	N	E	B		2	2	8	
4	No. of components or inscribed faces (record on reverse if possible)								
5	Type of memorial: 1 = flat 2 = head 3 = tomb 4 = foot 5 = tablet 6 = other	2							
6	Material and geology	LIMESTONE							
7	Stone mason or undertaker	NONE FOUND							
8	Which surfaces inscribed (facing N, S, E or W)								W
9	No. of people commemorated	3							
10	Condition of monument: 1=sound 2=displaced 3=leaning 4=collapsed 5=damaged	1							
11	Technique of inscription: 1 = incised 2 = carved in relief 3 = cast in relief 4 = lead letters 5 = painted	1							
12	Condition of inscription 1 = very good 2 = clear 3 = worn but decipherable 4 = partly legible 5 = illegible	3							
13	Dimensions (metric)	height	1	2	7	0			
		width		6	6	0			
		Thickness (or length in case of tombs)			6	5			
14	Date of memorial 1832+	Register Thomas Knight, Westbourne, Phoebe Knight, Westbourne, bu. 16 Jan. 1834, a. 12 // // bu. 19 July, 1832, a. 49 Sarah Knight, Westbourne, bu. 29 Aug. 1843, a. 59							
	Drawing or Photograph	Inscription							

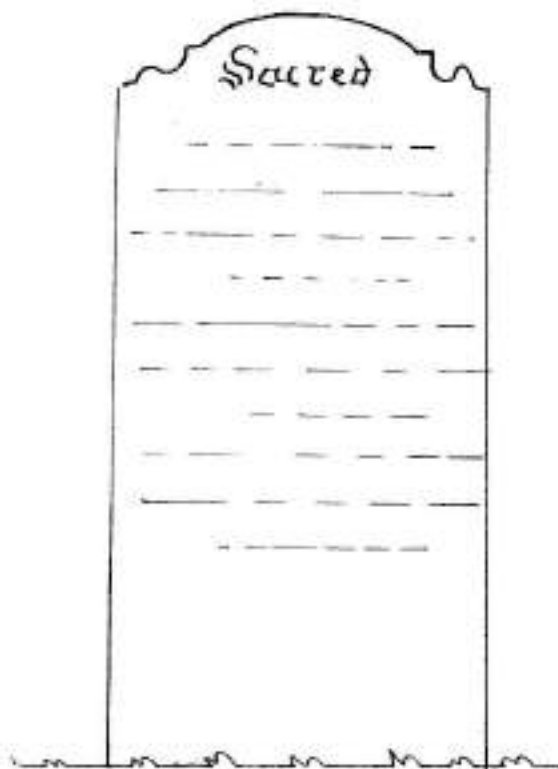

Sacred

to the Memory of
THOMAS KNIGHT
who Died the 19th of July 1832
Aged 49 Years.

Also SARAH Wife of the above
who Died the 23rd August 1843
Aged 59 Years.

PHOEBE Daughter of the above.
who Died the 16th of January 1834
Aged 12 Years.

Grave Memorial Recording Form: St. John the Baptist, Westbourne, W. Sussex

1 National Grid Reference	755 073	Date	0	7	0	8	0	1
2 Name of recorder(s)	KEITH LINDER							
3 Record No. of memorial (plus components i,ii,iii etc.)	N	E	B		2	2	9	
4 No. of components or inscribed faces (record on reverse if possible)								
5 Type of memorial: 1 = flat 2 = head 3 = tomb 4 = foot 5 = tablet 6 = other	CROSS & PLINTH							
6 Material and geology	GRANITE							
7 Stone mason or undertaker	NONE FOUND							
8 Which surfaces inscribed (facing N, S, E or W)	N, S, E							
9 No. of people commemorated	5 5							
10 Condition of monument: 1=sound 2=displaced 3=leaning 4=collapsed 5=damaged	1							
11 Technique of inscription: 1 = incised 2 = carved in relief 3 = cast in relief 4 = lead letters 5 = painted	4							
12 Condition of inscription 1 = very good 2 = clear 3 = worn but decipherable 4 = partly legible 5 = illegible	1							
13 Dimensions (metric)	height	3	2	6	0			
	width	1	0	6	5			
	Thickness (or length in case of tombs)				7	1	0	
14 Date of memorial	1919 +	Register						
Drawing or Photograph					Inscription			

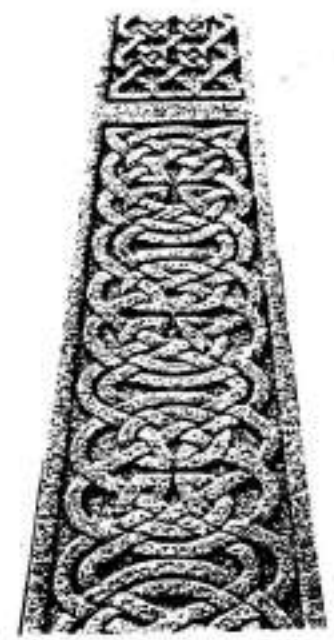
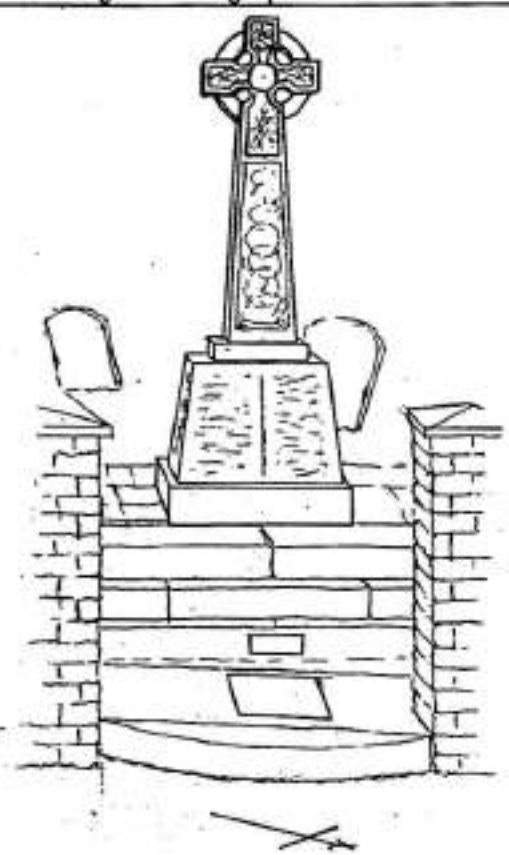

SEE OVER

East Face:

IN MEMORY OF MEN FROM WESTBOURNE,
WHO LAID DOWN THEIR LIVES IN
THE GREAT WAR 1914-1919

W.ADAMS, ROYAL SUSSEX.
E.P.CHAMBERLAIN, R.N.
R.COVIINGTON, ROYAL ENGINEERS.
T.COUSINS, HANTS REG^L.
H.T.GILBERT, H.M.S.BLACK PRINCE.
C.E.GOUGH, DORSET REG^L.
T.GRIFFITH, H.M.S. ABOUKIR.
N.HULL, ROYAL SUSSEX.
R.J.KENNARD, HANTS REG^L.
J.LANGLEY, R.F.A.
2ND LIEUT.G.H.MERRIKIN, LONDON REG^L.
J.MONK, ROYAL FUSILIERS.
C.NASH, SUBMARINE C31.
P.G.PORTER, HANTS REG^L.
T.PHILLIPS, H.M.S.BULWARK.

E.BOORNE, WORCESTERSHIRE.
C.J.COLLINS, H.M.S.GOOD HOPE.
E.CROUCH, H.M.S.BULWARK.
L.C.ELIAS, AUSTRALIAN CONTINGENT.
F.A.GLADDEN, NORFOLK REG^L.
A.GREEN, EAST SURREY.
E.HAMILTON, ROYAL SUSSEX.
W.H.HARRISON, H.M.S.ARIEL.
R.KEMP, HANTS REG^L.
H.R.MARCHANT, R.F.A.
A.MARSH, ROYAL SUSSEX.
W.NEWELL, H.M.S.BULWARK.
W.PILES, HANTS REG^L.
J.PORTSMOUTH, A.&S.H^{QS}.
F.PHILLIPS, H.M.S.GHURKA.

"GREATER LOVE HATH NO MAN THAN THIS, THAT A MAN LAY DOWN HIS LIFE FOR HIS FRIENDS"

South Face:

F.C.PARSONS, K.O.Y.L.I.
G.W.RICHARDSON, HANTS REG^L.
C.J.SOUTER, H.M.S.GOOD HOPE.
W.SELSBY, H.M.S.QUEEN MARY.
P.SMITH, H.M.S.MALAYA.
H.STENT, R.G.A.
G.STEVENS, QUEENS REG^L.
A.STILLWELL, ROYAL SUSSEX.
A.SMITH, H.M.S.AGINCOURT.
S.E.SULLY, R.A.S.C.
LIEUT.G.T.F.TOTHILL, ROYAL FUSILIERS.
C.TEE, H.M.S.INVINCIBLE.
P.TEE, ROYAL FUSILIERS.
A.TILBURY, ROYAL SUSSEX.
LIEUT.J.S.BINNEY SCOTT, SUBMARINE E3.

North Face:

G.TRUDGETT, ROYAL WARWICKS.
F.TILL, R.A.S.C.
A.VOICE, ROYAL SUSSEX.
B.WELLS, H.M.S.QUEEN MARY.
F.WELLS, R.M.L.I.
C.H.C.WEST, AUSTRALIAN CONTINGENT
J.WEST, H.M.S.COLIN BELLA.
L.WHITAKER, HANTS REG^L.
H.WAKEFORD, ROYAL SUSSEX.
ENG^{TS} COMD^T J.B.WILSHIN, H.M.S.MONMOUTH

(Sperling's record no. *M/A...*)

Grave Memorial Recording Form: St. John the Baptist, Westbourne, W. Sussex

1	National Grid Reference	755 073	Date	0	7	0	8	0	1
2	Name of recorder(s)	KEITH LINDER							
3	Record No. of memorial (plus components I,II,III etc.)	N	E	B		2	3	0	
4	No. of components or inscribed faces (record on reverse if possible)								
5	Type of memorial: 1 = flat 2 = head 3 = tomb 4 = foot 5 = tablet 6 = other	1							
6	Material and geology	STONE: LIMESTONE							
7	Stone mason or undertaker	NONE FOUND							
8	Which surfaces inscribed (facing N, S, E or W)	N/A							
9	No. of people commemorated	29							
10	Condition of monument: 1=sound 2=displaced 3=leaning 4=collapsed 5=damaged	1							
11	Technique of inscription: 1 = incised 2 = carved in relief 3 = cast in relief 4 = lead letters 5 = painted	1							
12	Condition of inscription 1 = very good 2 = clear 3 = worn but decipherable 4 = partly legible 5 = illegible	1							
13	Dimensions (metric)	height	6	4	0	width	5	1	5
	Thickness (or length in case of tombs)	/	/	/	/				
14	Date of memorial 1977 +	Register							
	(See memorial to Rear Admiral Longworth)								
	(no. 231)								
	Drawing or Photograph	Inscription							

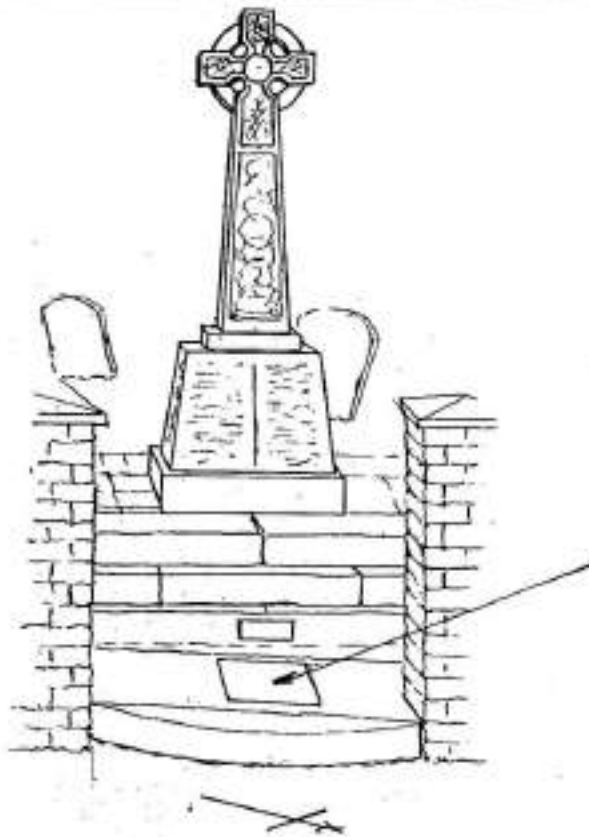

1939 - 1945

- | | |
|-----------------------------------|-------------------------------|
| K. ATKINSON | L. GILLARD |
| A. AYLWARD | F. HARRISON |
| D. BADCOCK | A. KNIGHT |
| G. BAILEY | P. LASHLY |
| G. BEASLEY | J. McCRAE |
| A. BOYNS | R. PHILLIPS |
| F. CONSTABLE | W. PRYKE |
| C. DENHAM | A. ROBINSON |
| E. FARDEN | C. ROBINSON |
| A. FARMER | R. ROBINSON _{D.S.M.} |
| C. FOSSEY | W. SOLE |
| W. GARDNER | W. SYLVESTER |
| T. GODWIN | E. TUTT |
| D. GREGORY | R. WEST |
| R. GORDON-SMITH _{D.S.C.} | |

Grave Memorial Recording Form: St. John the Baptist, Westbourne, W. Sussex

1 National Grid Reference	755 073	Date	0	7	0	8	0	1	
2 Name of recorder(s)	KEITH LINDER								
3 Record No. of memorial (plus components i,ii,iii etc.)							2	3	
4 No. of components or inscribed faces (record on reverse if possible)								1	
5 Type of memorial: 1 = flat 2 = head 3 = tomb 4 = foot 5 = tablet 6 = other	BRASS PLATE								6
6 Material and geology	bronze								
7 Stone mason or undertaker									
8 Which surfaces inscribed (facing N, S, E or W)									
9 No. of people commemorated								1	
10 Condition of monument: 1=sound 2=displaced 3=leaning 4=collapsed 5=damaged								1	
11 Technique of inscription: 1 = incised 2 = carved in relief 3 = cast in relief 4 = lead letters 5 = painted								1	
12 Condition of inscription 1 = very good 2 = clear 3 = worn but decipherable 4 = partly legible 5 = illegible								1	
13 Dimensions (metric)	height		1	0	0				
	width		1	5	0				
	Thickness (or length in case of tombs)								
14 Date of memorial	1977 +	Register							

Drawing or Photograph

Inscription

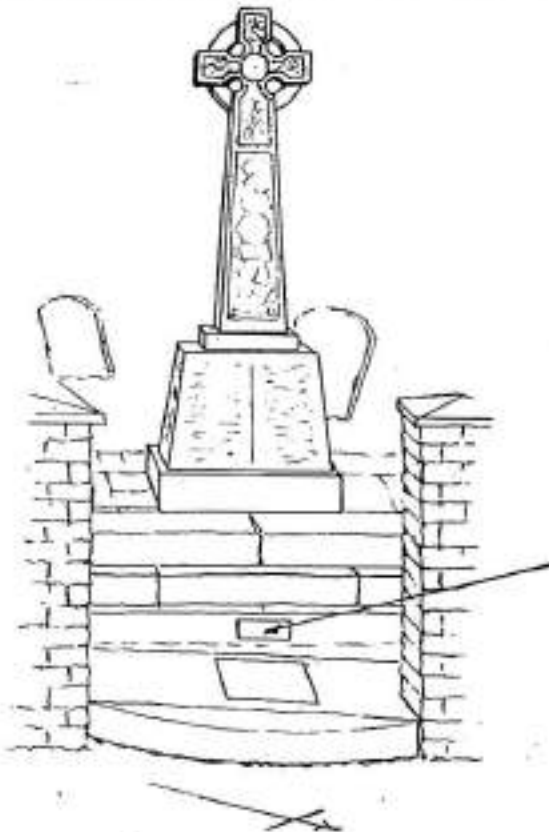

THE 1939-1945 MEMORIAL
was given in memory of
Rear Admiral
CECIL RAMSDEN LANGWORTHY PARRY
CB DSO
1901-1977

Grave Memorial Recording Form: St. John the Baptist, Westbourne, W. Sussex

1	National Grid Reference	755 073	Date	2	5	0	7	0	0
2	Name of recorder(s)	BERYL LINDER							
3	Record No. of memorial (plus components i,ii,iii etc.)	N	E	B		2	3	2	
4	No. of components or inscribed faces (record on reverse if possible)								
5	Type of memorial: 1 = flat 2 = head 3 = tomb 4 = foot 5 = tablet 6 = other	set in paving round War Memorial							
6	Material and geology	LIMESTONE: PORTLAND TYPE							
7	Stone mason or undertaker	NONE FOUND							
8	Which surfaces inscribed (facing N, S, E or W)	N/A							
9	No. of people commemorated	2							
10	Condition of monument: 1=sound 2=displaced 3=leaning 4=collapsed 5=damaged	2 5							
11	Technique of inscription: 1 = incised 2 = carved in relief 3 = cast in relief 4 = lead letters 5 = painted	1							
12	Condition of inscription 1 = very good 2 = clear 3 = worn but decipherable 4 = partly legible 5 = illegible	2							
13	Dimensions (metric)	height	6	6	0	width	3	4	0
		Thickness (or length in case of tombs)							
14	Date of memorial	1847+	Register						
Drawing or Photograph					Inscription				

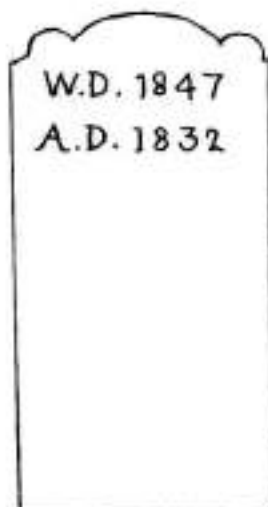

William and Ann Day
(headstone no. NEB 244)

Grave Memorial Recording Form: St. John the Baptist, Westbourne, W. Sussex

1	National Grid Reference	755 073	Date	2	5	0	7	0	0
2	Name of recorder(s)	BERYL LINDER							
3	Record No. of memorial (plus components i,ii,iii etc.)	N	E	B	2	3	3		
4	No. of components or inscribed faces (record on reverse if possible)								1
5	Type of memorial: 1 = flat 2 = head 3 = tomb 4 = foot 5 = tablet 6 = other	re-used in paving, War Memorial 4							
6	Material and geology	LIMESTONE							
7	Stone mason or undertaker	NONE FOUND							
8	Which surfaces inscribed (facing N, S, E or W)	N/A	/	/	/	/	/	/	/
9	No. of people commemorated								1
10	Condition of monument: 1=sound 2=displaced 3=leaning 4=collapsed 5=damaged								2 5
11	Technique of inscription: 1 = incised 2 = carved in relief 3 = cast in relief 4 = lead letters 5 = painted								1
12	Condition of inscription 1 = very good 2 = clear 3 = worn but decipherable 4 = partly legible 5 = illegible								4
13	Dimensions (metric)	height		6	6	0			
		width		3	8	0			
		Thickness (or length in case of tombs)	/	/	/	/	/	/	/
14	Date of memorial	1738	Register						
Drawing or Photograph					Inscription				



Perhaps footstone to Sperling no. 143
Thomas Hurst 1738 which is
poss. our OR 658 fragment

Grave Memorial Recording Form: St. John the Baptist, Westbourne, W. Sussex

1	National Grid Reference	755 073	Date	2	7	0	7	0	0
2	Name of recorder(s)	BERYL LINDER							
3	Record No. of memorial (plus components i,ii,iii etc.)	N	E	B		2	3	4	
4	No. of components or inscribed faces (record on reverse if possible)	1							
5	Type of memorial: 1 = flat 2 = head 3 = tomb 4 = foot 5 = tablet 6 = other	Set in paving round War Memorial 4							
6	Material and geology	LIMESTONE: PORTLAND TYPE							
7	Stone mason or undertaker	NONE FOUND							
8	Which surfaces inscribed (facing N, S, E or W)	N/A							
9	No. of people commemorated	1							
10	Condition of monument: 1=sound 2=displaced 3=leaning 4=collapsed 5=damaged	2 5							
11	Technique of inscription: 1 = incised 2 = carved in relief 3 = cast in relief 4 = lead letters 5 = painted	1							
12	Condition of inscription 1 = very good 2 = clear 3 = worn but decipherable 4 = partly legible 5 = illegible	3							
13	Dimensions (metric)	height	6	6	0				
		width	3	0	0				
		Thickness (or length in case of tombs)	/	/	/				
14	Date of memorial	1845 +	Register						
Drawing or Photograph					Inscription				

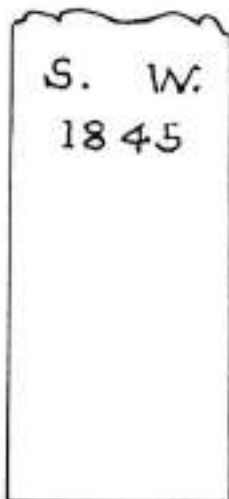

(Sophia Wright; headstone no NEB 24)

Grave Memorial Recording Form: St. John the Baptist, Westbourne, W. Sussex

1	National Grid Reference	755 073	Date	2	5	0	7	0	0	
2	Name of recorder(s)	BERYL LINDER								
3	Record No. of memorial (plus components i,ii,iii etc.)	N		E		B		2	3	5
4	No. of components or inscribed faces (record on reverse if possible)									
5	Type of memorial: 1 = flat 2 = head 3 = tomb 4 = foot 5 = tablet 6 = other	re-used in paving round War Memorial								
6	Material and geology	LIMESTONE								
7	Stone mason or undertaker	NONE FOUND								
8	Which surfaces inscribed (facing N, S, E or W)	N/A								
9	No. of people commemorated	1								
10	Condition of monument: 1=sound 2=displaced 3=leaning 4=collapsed 5=damaged	2 5								
11	Technique of inscription: 1 = incised 2 = carved in relief 3 = cast in relief 4 = lead letters 5 = painted	1								
12	Condition of inscription 1 = very good 2 = clear 3 = worn but decipherable 4 = partly legible 5 = illegible	3								
13	Dimensions (metric)	height	6	6	0					
		width	3	6	0					
		Thickness (or length in case of tombs)								
14	Date of memorial	1860	Register							

Drawing or Photograph

Inscription

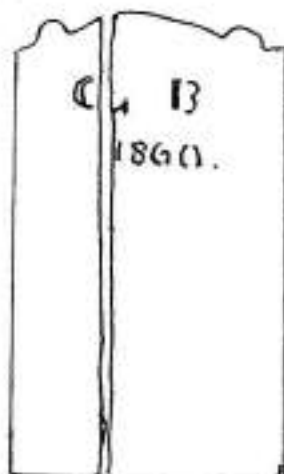

Probably George Bowman, 1860, SE 4

Grave Memorial Recording Form: St. John the Baptist, Westbourne, W. Sussex

1	National Grid Reference	755 073	Date	1	5	0	8	0	0		
2	Name of recorder(s)	BERYL LINDER									
3	Record No. of memorial (plus components i,ii,iii etc.)	N		E		B		2	3	6	
4	No. of components or inscribed faces (record on reverse if possible)									2	
5	Type of memorial: 1 = flat 2 = head 3 = tomb 4 = foot 5 = tablet 6 = other									3	
6	Material and geology	LIMESTONE, with some sandy portions									
7	Stone mason or undertaker	NONE FOUND									
8	Which surfaces inscribed (facing N, S, E or W)								N	S	
9	No. of people commemorated									2	
10	Condition of monument: 1=sound 2=displaced 3=leaning 4=collapsed 5=damaged									1	
11	Technique of inscription: 1 = incised 2 = carved in relief 3 = cast in relief 4 = lead letters 5 = painted									1	
12	Condition of inscription 1 = very good 2 = clear 3 = worn but decipherable 4 = partly legible 5 = illegible									3	
13	Dimensions (metric)	height		width		Thickness (or length in case of tombs)					
		3		6		1		8 0 0			
14	Date of memorial ? 1837 or 1849	Register Elizabeth Robbins; Westbourne George Robbins, Westbourne, bu. 21 Aug. 1849, a. 77									
									bu. 10 July 1837		
Drawing or Photograph					Inscription						

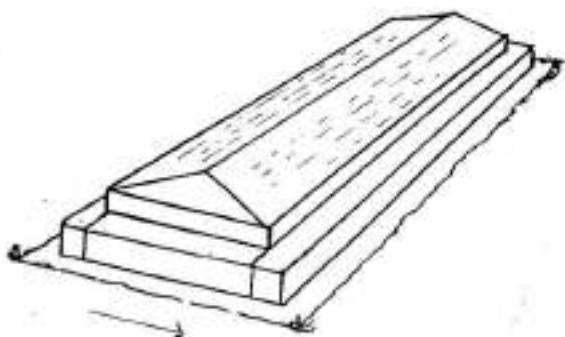

SACRED to the Memory of
 ELIZABETH the Wife of
 GEORGE ROBBINS
 who Died July 12th 1837 Aged 73 Years

 SACRED to the Memory of
 GEORGE ROBBINS
 who Died August 17 1849
 Aged 77 Years

Grave Memorial Recording Form: St. John the Baptist, Westbourne, W. Sussex

1	National Grid Reference	755 073	Date	1	8	0	0	
2	Name of recorder(s)	SHIRLEY HARVEY - WHITING						
3	Record No. of memorial (plus components i,ii,iii etc.)	N	E	B	2	3	7	
4	No. of components or inscribed faces (record on reverse if possible)	3						
5	Type of memorial: 1 = flat 2 = head 3 = tomb 4 = foot 5 = tablet 6 = other	plus body stone					4	2
6	Material and geology	STONE						
7	Stone mason or undertaker	not found						
8	Which surfaces inscribed (facing N, S, E or W)	W						
9	No. of people commemorated	1						
10	Condition of monument: 1=sound 2=displaced 3=leaning 4=collapsed 5=damaged	1						
11	Technique of inscription: 1 = incised 2 = carved in relief 3 = cast in relief 4 = lead letters 5 = painted	1						
12	Condition of inscription 1 = very good 2 = clear 3 = worn but decipherable 4 = partly legible 5 = illegible	3						
13	Dimensions (metric)	height	1	4	0	0		
		width		6	6	0		
		Thickness (or length in case of tombs)			7			
14	Date of memorial	1831+	Register John Cousins. Prinsted Lodge buried 9th July 1831 Aged 74 years.					
Drawing or Photograph				Inscription				

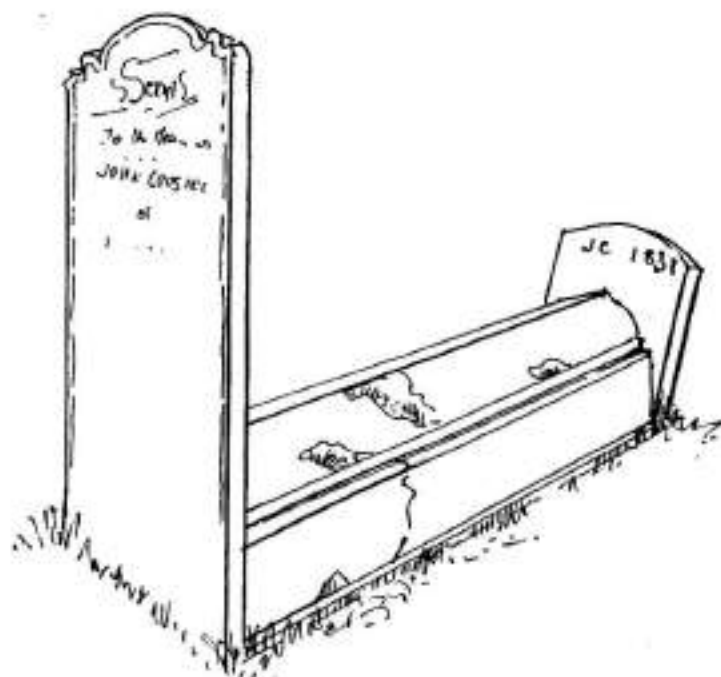

See 1417 - Footstone & body slab

(i)

~~Secured~~

To the Memory of
JOHN COUSINS
of
Prinsted Lodge
who departed this life
the 4th day of July 1831
aged 74 Years.

over

Foot Stone NEB 237 ii

- h. 46 cms
- w. 53.5 cms
- d. 6.3 cms

faces W limestone

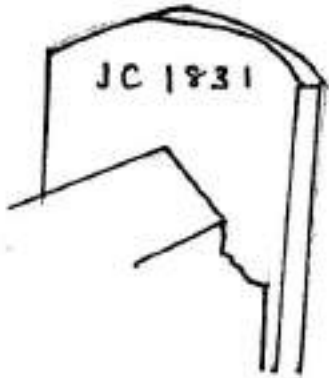

BODY SLAB iii

- L. 183 cms
- w. 53.5 cms
- h. 36 cms.

Grave Memorial Recording Form: St. John the Baptist, Westbourne, W. Sussex

1	National Grid Reference	755 073	Date	0	8	0	8	0	0	
2	Name of recorder(s)	Beryl Linder								
3	Record No. of memorial (plus components i,ii,iii etc.)	N		E		B		2	3	8
4	No. of components or inscribed faces (record on reverse if possible)									1
5	Type of memorial: 1 = flat 2 = head 3 = tomb 4 = foot 5 = tablet 6 = other									3
6	Material and geology	LIMESTONE								
7	Stone mason or undertaker	NONE FOUND								
8	Which surfaces inscribed (facing N, S, E or W)									E
9	No. of people commemorated									1
10	Condition of monument: 1=sound 2=displaced 3=leaning 4=collapsed 5=damaged	large chips and a crack across								5
11	Technique of inscription: 1 = incised 2 = carved in relief 3 = cast in relief 4 = lead letters 5 = painted									1
12	Condition of inscription 1 = very good 2 = clear 3 = worn but decipherable 4 = partly legible 5 = illegible									4
13	Dimensions (metric)	including plinth		height	width					
				3	7		0 0			
					8		0			
		Thickness (or length in case of tombs)		1		9		5 0		
14	Date of memorial	1843+ or 1858+	Register George Smith, Havant, bu. 2 Nov.							
		Joseph Smith, Emsworth, bu. 26 Aug. 1858, aged 27							1843 a-12	
Drawing or Photograph					Inscription					

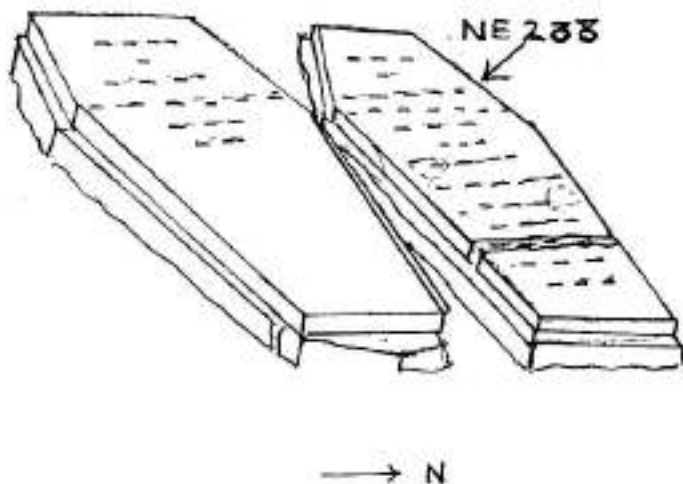

IN MEMORY
of
GEORGE SMITH Jun^r
who departed this Life
the 26th of October 1843
Aged 13 Years
[JOS] EPH SMITH
second son of the late
GEORGE SMITH E[^{sq.}]
[who] was drowned in [Emsworth]
Harbour by the upsetting of a
Pleasure Boat on the 21st of
August 1858 Aged 27 Years

Two of the others who perished in this accident were George Shum Shear, also buried in Westbourne churchyard (no. NEB 203), and the Rev. Herbert Morse, curate of St. James's, Emsworth, who is buried in Warblington churchyard (no. SE 623 of the Warblington record). Morse is commemorated also by a tablet in St. James's Church.

acc. to Sperling, Joseph was a solicitor and second son of George, his no. 267.
our 239

Grave Memorial Recording Form: St. John the Baptist, Westbourne, W. Sussex

1	National Grid Reference	755 073	Date	0	8	0	8	0	0
2	Name of recorder(s)	Beryl Linden							
3	Record No. of memorial (plus components i,ii,iii etc.)	N		E		B		2 3 9	
4	No. of components or inscribed faces (record on reverse if possible)	1							
5	Type of memorial: 1 = flat 2 = head 3 = tomb 4 = foot 5 = tablet 6 = other	3							
6	Material and geology	LIMESTONE							
7	Stone mason or undertaker	NONE FOUND							
8	Which surfaces inscribed (facing N, S, E or W)								E
9	No. of people commemorated	2							
10	Condition of monument: 1=sound 2=displaced 3=leaning 4=collapsed 5=damaged								5
11	Technique of inscription: 1 = incised 2 = carved in relief 3 = cast in relief 4 = lead letters 5 = painted								1
12	Condition of inscription 1 = very good 2 = clear 3 = worn but decipherable 4 = partly legible 5 = illegible								3
13	Dimensions (metric)	inci. plinth	height	3	0	0			
			width	7	6	0			
		Thickness (or length in case of tombs)	1	9	5	0			
14	Date of memorial	1838 +	Register George Smith, Havant. b.u. 14 May, 1838 a.47						
Drawing or Photograph					Inscription				

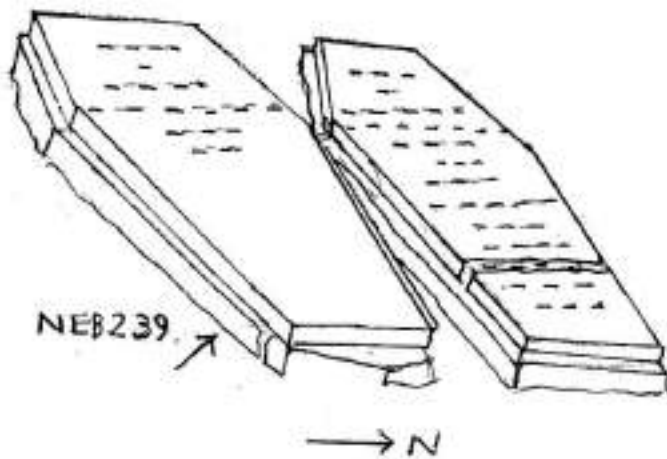

IN MEMORY
of
GEORGE SMITH Esq
who departed this Life
the 7th of May 1838
Aged 47 Years

acc. to Spurling the s. of this no. 268
the large tomb (our 247
Joseph Smith

Grave Memorial Recording Form: St. John the Baptist, Westbourne, W. Sussex

1 National Grid Reference	755 013	Date	1	5	0	8	0	0
2 Name of recorder(s)	JOSEPHINE HALLETT							
3 Record No. of memorial (plus components i,ii,iii etc.)	N		E		B		2 4 0	
4 No. of components or inscribed faces (record on reverse if possible)	1							
5 Type of memorial: 1 = flat 2 = head 3 = tomb 4 = foot 5 = tablet 6 = other	2							
6 Material and geology	LIMESTONE							
7 Stone mason or undertaker	NONE FOUND							
8 Which surfaces inscribed (facing N, S, E or W)								W
9 No. of people commemorated	1							
10 Condition of monument: 1=sound 2=displaced 3=leaning 4=collapsed 5=damaged								1
11 Technique of inscription: 1 = incised 2 = carved in relief 3 = cast in relief 4 = lead letters 5 = painted								1
12 Condition of inscription 1 = very good 2 = clear 3 = worn but decipherable 4 = partly legible 5 = illegible								2
13 Dimensions (metric)			height	1	1	7	5	
			width	6		5	5	
			Thickness (or length in case of tombs)			7	0	
14 Date of memorial	1847	Register George Thomas Lyne, Westbourne, bu. 7 May 1847, a. 44						
Drawing or Photograph				Inscription				

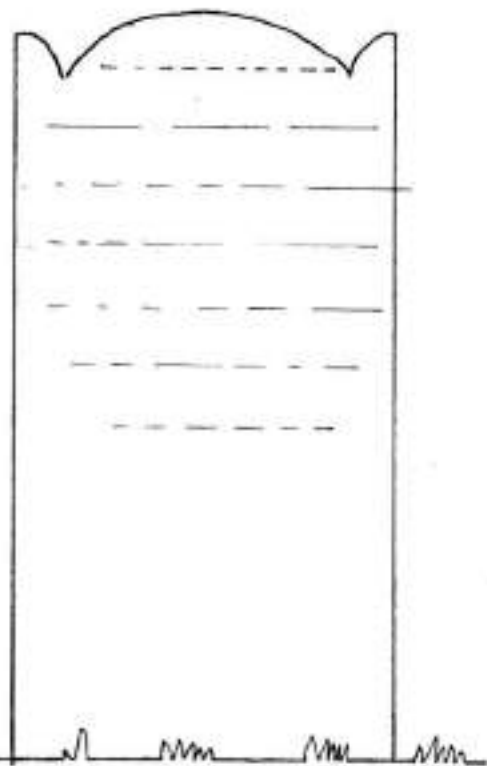

TO THE MEMORY OF
 GEORGE THOMAS LYNE
 SON OF CAPTAIN THOMAS
 AND ELIZABETH LYNE
 WHO DEPARTED THIS LIFE
 THE 2ND OF MAY 1847
 AGED 44 YEARS.

Footstone is no. NW 102B

Grave Memorial Recording Form: St. John the Baptist, Westbourne, W. Sussex

1	National Grid Reference	755 073	Date	1	5	8	0	0
2	Name of recorder(s)	SHIRLEY HARVEY-WHITING						
3	Record No. of memorial (plus components i,ii,iii etc.)	N	E	3	2	4	1	
4	No. of components or inscribed faces (record on reverse if possible)							
5	Type of memorial: 1 = flat 2 = head 3 = tomb 4 = foot 5 = tablet 6 = other	2						
6	Material and geology	LIME STONE						
7	Stone mason or undertaker	NONE FOUND						
8	Which surfaces inscribed (facing N, S, E or W)	W						
9	No. of people commemorated	2						
10	Condition of monument: 1=sound 2=displaced 3=leaning 4=collapsed 5=damaged	1						
11	Technique of inscription: 1 = Incised 2 = carved in relief 3 = cast in relief 4 = lead letters 5 = painted	1						
12	Condition of inscription 1 = very good 2 = clear 3 = worn but decipherable 4 = partly legible 5 = illegible	2						
13	Dimensions (metric)	height	1	1	8	0		
		width		7	0	0		
		Thickness (or length in case of tombs)			7	0		
14	Date of memorial 1848 +	Register Elizabeth Lyne, Westbourne, Thomas Lyne, WB, bu. 4 Feb 1848 a.79 // bu. 29 Oct. 1832, a.56						
Drawing or Photograph				Inscription				

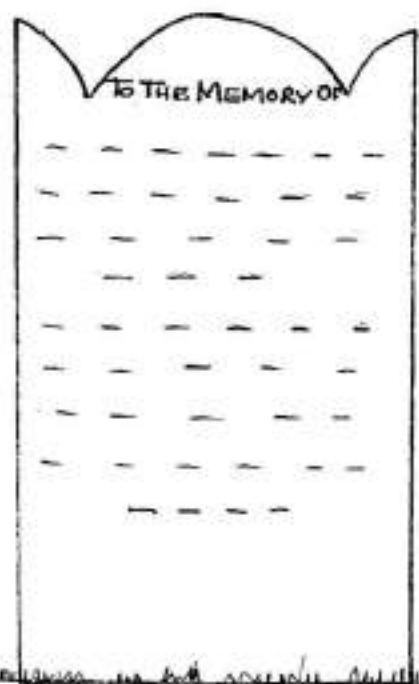

TO THE MEMORY OF
 CAPTAIN THOMAS LYNE.R.N.
 WHO DEPARTED THIS LIFE
 THE 1ST OF FEBRUARY 1848
 AGED 79 YEARS.
 ALSO OF ELIZABETH
 WIFE OF THE ABOVE
 WHO DEPARTED THIS LIFE
 THE 26 OF OCTOBER 1832
 AGED 56 YEARS

Grave Memorial Recording Form: St. John the Baptist, Westbourne, W. Sussex

1	National Grid Reference	755 073	Date	1	5	0	8	0	0
2	Name of recorder(s)	BERYL LINDER							
3	Record No. of memorial (plus components I, II, III etc.)	N E B		2	4	2			
4	No. of components or inscribed faces (record on reverse if possible)								
5	Type of memorial: 1 = flat 2 = head 3 = tomb 4 = foot 5 = tablet 6 = other	2							
6	Material and geology	LIMESTONE							
7	Stone mason or undertaker	NONE FOUND							
8	Which surfaces inscribed (facing N, S, E or W)								
9	No. of people commemorated	2							
10	Condition of monument: 1=sound 2=displaced 3=leaning 4=collapsed 5=damaged	1							
11	Technique of inscription: 1 = incised 2 = carved in relief 3 = cast in relief 4 = lead letters 5 = painted	5 1							
12	Condition of inscription 1 = very good 2 = clear 3 = worn but decipherable 4 = partly legible 5 = illegible	1							
13	Dimensions (metric)	height	1	1	7	0			
		width		6	9	0			
		Thickness (or length in case of tombs)			7	0			
14	Date of memorial	1828+	Register	Frances Lyne bu. 15 Aug. 1829, a. 18					
	Philip Lyne Lyne, Westbourne, ba 22 Oct. Oct 1853 a. 35 //								
Drawing or Photograph					Inscription				

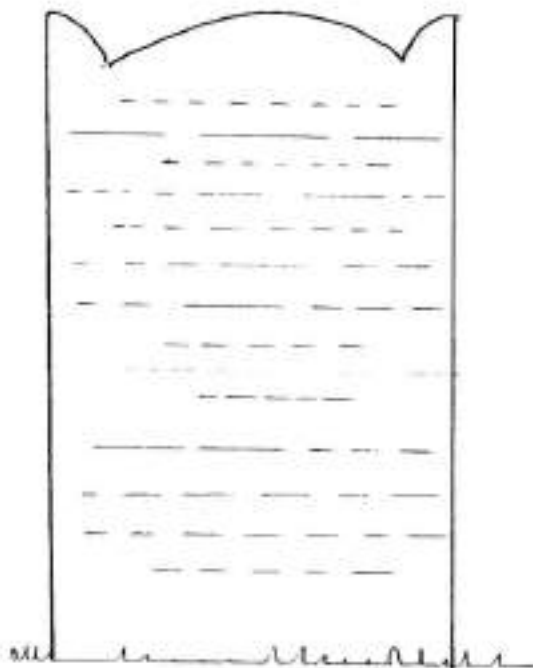

Below line 8 is a recessed section suggesting that the surface, perhaps bearing an epitaph, has been removed to allow Philip's inscription to be added.

TO THE MEMORY OF
FRANCES REBECCA LYNE
DAUGHTER OF
CAPTAIN THOMAS LYNE R.N.
AND ELIZABETH LYNE
SHE DEPARTED THIS LIFE
THE 12TH OF AUGUST 1828
AGED 18 YEARS
ALSO OF
PHILIP LYNE LYNE
HE DEPARTED THIS LIFE
THE 15TH OF OCTOBER 1853
AGED 34 YEARS.

Discrepancy in year of Frances's death:
1828 on headstone, but 1829 on foot-
stone and in register.

Grave Memorial Recording Form: St. John the Baptist, Westbourne, W. Sussex

1	National Grid Reference	755 073	Date	1	5	0	8	0	0	
2	Name of recorder(s)	KEITH LINDER								
3	Record No. of memorial (plus components i,ii,iii etc.)	N		E		B		2	4	3
4	No. of components or inscribed faces (record on reverse if possible)									1
5	Type of memorial: 1 = flat 2 = head 3 = tomb 4 = foot 5 = tablet 6 = other									2
6	Material and geology	STONE: LIMESTONE								
7	Stone mason or undertaker	NONE FOUND								
8	Which surfaces inscribed (facing N, S, E or W)									W
9	No. of people commemorated									1
10	Condition of monument: 1=sound 2=displaced 3=leaning 4=collapsed 5=damaged									1
11	Technique of inscription: 1 = incised 2 = carved in relief 3 = cast in relief 4 = lead letters 5 = painted									1
12	Condition of inscription 1 = very good 2 = clear 3 = worn but decipherable 4 = partly legible 5 = illegible									3
13	Dimensions (metric)	height		1	0	8	0			
		width			6	6	0			
		Thickness (or length in case of tombs)				6	5			
14	Date of memorial	1845 +	Register Sophia Wright bu. 21 Aug 1845, aged 32, Hermitage Sophia d. William & Ann Day sep. 27 March 1814 - Millwright, Hermitage							
Drawing or Photograph					Inscription					

In
Memory of
SOPHIA the Affectionate *Wife* of
JOHN HARRIS WRIGHT
and *Daughter* of WILLIAM
and ANN DAY
who died the 14th of August 1845
Aged 32 Years
*after a Long and painful
Illness which She endured
with peace and resignation*

In
Memory of
SOPHIA the Affectionate *Wife* of
JOHN HARRIS WRIGHT
and *Daughter* of WILLIAM
and ANN DAY
who died the 14th of August 1845
Aged 32 Years
*After a Long and painful
Illness which She endured
with peace and resignation*

Footstone NEB 234

Grave Memorial Recording Form: St. John the Baptist, Westbourne, W. Sussex

1 National Grid Reference	755 073	Date	1	5	0	8	0	0
2 Name of recorder(s)	June Marshall							
3 Record No. of memorial (plus components i,ii,iii etc.)	N E 8		2		4		4	
4 No. of components or inscribed faces (record on reverse if possible)	1							
5 Type of memorial: 1 = flat 2 = head 3 = tomb 4 = foot 5 = tablet 6 = other	2							
6 Material and geology	Limestone							
7 Stone mason or undertaker	Not known							
8 Which surfaces inscribed (facing N, S, E or W)								W
9 No. of people commemorated								2
10 Condition of monument: 1=sound 2=displaced 3=leaning 4=collapsed 5=damaged								1
11 Technique of inscription: 1 = incised 2 = carved in relief 3 = cast in relief 4 = lead letters 5 = painted - remains of black paint								5 1
12 Condition of inscription 1 = very good 2 = clear 3 = worn but decipherable 4 = partly legible 5 = illegible								1
13 Dimensions (metric)	height		1	3	6	0		
	width		7		4		0	
	Thickness (or length in case of tombs)		7		0			
14 Date of memorial	1847†	Register Ann Day, Hermitage, bu. 19 May 1832, a 56						
	William Day, Hermitage, bu. 11 July 1847 a. 75							
Drawing or Photograph				Inscription				



Sacred
 to the Memory of
WILLIAM DAY
 who died the 8th of July 1847
 Aged 75 Years
 Also ANN Wife of the above
WILLIAM DAY
 who died the 13th of May 1832
 Aged 55 Years

Grave Memorial Recording Form: St. John the Baptist, Westbourne, W. Sussex

1 National Grid Reference	7 5 5 0 7 3	Date	1	5	8	0	0
2 Name of recorder(s)	SHIRLEY HARVEY - WHITING						
3 Record No. of memorial (plus components i,ii,iii etc.)	N	E	B	2	4	5	
4 No. of components or inscribed faces (record on reverse if possible)							
5 Type of memorial: 1 = flat 2 = head 3 = tomb 4 = foot 5 = tablet 6 = other	1						
6 Material and geology	STONE; LIMESTONE						
7 Stone mason or undertaker	NONE FOUND						
8 Which surfaces inscribed (facing N, S, E or W)	W						
9 No. of people commemorated	1						
10 Condition of monument: 1=sound 2=displaced 3=leaning 4=collapsed 5=damaged	1						
11 Technique of inscription: 1 = incised 2 = carved in relief 3 = cast in relief 4 = lead letters 5 = painted	1						
12 Condition of inscription 1 = very good 2 = clear 3 = worn but decipherable 4 = partly legible 5 = illegible	2						
13 Dimensions (metric)	height	1	1	5	0		
	width		6	2	0		
	Thickness (or length in case of tombs)			6	5		
14 Date of memorial	1842	Register Ann Day, Hermitage, bu. 8 Aug. 1842					
		Ellen Wright, Hermitage, bu. 15 Oct. 1842, aged 1. aged 38					
Drawing or Photograph				Inscription			

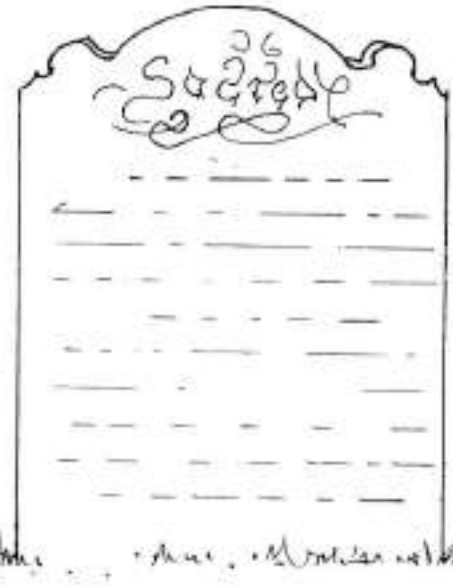

Sacred

to the Memory of
 ANN Eldest Daughter of
 WILLIAM and ANNDAY
 who Died 2nd of August 1842
 Aged 38 Years.
 Also ELLEN Daughter of
 JOHN and SOPHIA WRIGHT
 and Niece of the above
 who Died 10th of October 1842
 Aged 1 Year and 4 Months